

ANDRITZ Ritz Product range

Pumps and motors



Welcome to the world of ANDRITZ Ritz



▲ Water supply



▲ Mining



▲ Industry



▲ Sewage

For over 125 years, the name ANDRITZ Ritz has stood for the highest reliability and quality Made in Germany.

With our extensive product line, we support our customers worldwide in successfully mastering demanding pumping tasks in the fields of water supply, mining, industry and sewage.

For planners and users. The ANDRITZ Ritz product range.

This brochure will give you an overview of our product range and will help you to quickly find the right product for your specific applications. We have prepared detailed technical information on the individual product groups, and would be happy to provide them to you on request.

Welcome to the world of ANDRITZ Ritz

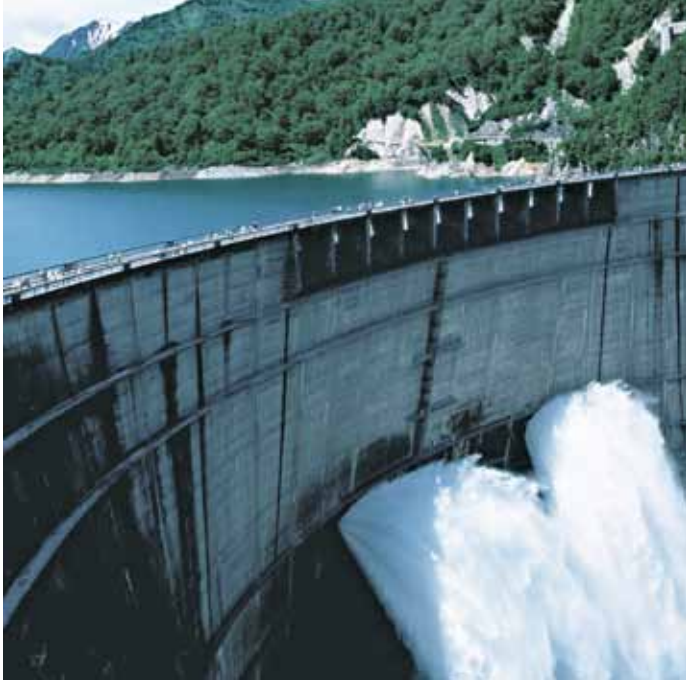

For water supply. More water – less costs.

In all sectors of water management, ANDRITZ Ritz pumps play a major role in the abstraction and distribution of this valuable resource. What is more, the high efficiency of our products makes it possible to reduce operating costs. This means that investment in a ANDRITZ Ritz pump amounts to less than 1 % of the energy costs over ten years.



For mining. Highest reliability under severest conditions.

One of the most important requirements for trouble-free extraction operations is pumping the accumulated mine water out of the working area. Mine operators all over the world rely on single-suction and double-suction submersible motor pumps and high-pressure pumps from ANDRITZ Ritz to carry out this important task.



For industry. Flexibility and highest economics.

ANDRITZ Ritz industrial pumps can be used in almost any application involving the pumping of coolants, auxiliary substances or operating media in secondary circuits, or where demanding washing and cleaning processes are necessary in raw materials handling. ANDRITZ Ritz pumps can operate in extreme temperatures and under high pressure, in aggressive and corrosive media and media containing solids, transporting coolants, lubricants, acids, bases and oils.



For sewage. Long service life – maximum economics.

Almost anywhere that sewage has to be moved, wherever reliability and cost-effectiveness are the main criteria in intelligent decisions, solutions from ANDRITZ Ritz are the right choice.

Contents

Pumps for water supply	06
Pumps for mining	08
Pumps for industry	10
Pumps for sewage	12
ES. End suction pumps	14
ASC. Axial split case pumps	15
HP. High-pressure pumps	15
SU. Submersible motor pumps	16
MS-T. Modular Shaft Technology	17
HDM. Double-suction submersible motor pumps	18
HDM. Heavy Duty Mining	19
SM. Submersible motors	20
MC-T. Modular Cooling Technology	21
SD. Sewage dry pumps	22
SW. Sewage wet pumps	23
Types of installation	24
Impellers	26
WinPump	28
Additional product information	29

Pumps for water supply

ANDRITZ Ritz pumps for water abstraction

- Various heads
- Various water qualities
- High water temperatures
- Numerous designs
- Maintenance-free solutions
- Flexible adaptation to changing pumping conditions with **MS-T – Modular Shaft Technology** (more on page 17)

ANDRITZ Ritz pumps for water distribution

- Hydraulically optimised solutions (reduced energy costs)
- The right design for every requirement
- For extremely low to extremely high pressures
- Adaptable solutions in the field of pressure boosting
- Complete solutions
- Low-wear
- Extremely long service life



The product range for water supply – an overview

	ES	ASC	HP	SU
Type	End suction pumps	Axial split case pumps	High-pressure pumps	Submersible motor pumps
Design	01 03 04	07	45 46 49 55	56 62 63 64 66
Q	up to 4,000 m ³ /h	up to 3,500 m ³ /h	up to 800 m ³ /h	up to 500 m ³ /h
H	up to 100 m	up to 150 m	up to 400 m	up to 700 m
p	up to 16 bar	up to 25 bar	up to 40 bar	up to 100 bar
t	up to +140°C	up to +110°C	up to +140°C	up to +75°C
n	up to 3 600 rpm	up to 1 800 rpm	up to 3 600 rpm	up to 3 600 rpm
Materials	grey cast iron, bronze, ductile iron, stainless steel	grey cast iron, ductile iron, duplex stainless steel	grey cast iron, bronze, aluminium bronze, stainless steel	grey cast iron, bronze, aluminium bronze, stainless steel * An ideal drive for the SUs are the SM submersible motors. More information on these is available on page 20.

14 ES. End suction pumps

15 ASC. Axial split case pumps

15 HP. High-pressure pumps

16 SU. Submersible motor pumps

Pumps for mining

ANDRITZ Ritz pumps for water drainage in surface and underground mining

- High heads
- Large capacities
- High operational reliability
- Maintenance-free solutions
- High-quality material designs
- Long service life
- High efficiency
- Flexible adaptation to changing pumping conditions with **MS-T – Modular Shaft Technology** (more on page 17)
- Solutions for the most extreme operating conditions with **HDM – Heavy Duty Mining** (more on page 19)



The product range for mining – an overview

	SU	HDM	HP
Type	Single-suction submersible motor pumps	Double-suction submersible motor pumps	High-pressure pumps
Design	56 62 63 64 66	61 67 68	45 46 49 55
Q	up to 500 m ³ /h	up to 6,000 m ³ /h	up to 800 m ³ /h
H	up to 700 m	up to 1,500 m	up to 400 m
p	up to 100 bar	up to 150 bar	up to 40 bar
t	up to +75°C	up to +75°C	up to +140°C
n	up to 3 600 rpm	up to 3 600 rpm	up to 3 600 rpm
Materials	grey cast iron, bronze, aluminium bronze, stainless steel	ductile iron, aluminium bronze, duplex stain- less steel	grey cast iron, bronze, aluminium bronze, stainless steel
* An ideal drive for the SUs and HDMs are the SM submersible motors. More information on these is available on page 20.			

15 HP. High-pressure pumps

16 SU. Submersible motor pumps

18 HDM. Double-suction submersible motor pumps

Pumps for industry

ANDRITZ Ritz pumps for practically any industrial application, e. g. cooling circuits, service water circuits, process water circuits, coolant and lubricant transport, industrial washing and cleaning processes, fire-fighting water systems, off-shore facilities, etc.

- Requirements-oriented capacities and heads
- Numerous types
- High temperatures of the medium being pumped
- Various qualities of the medium being pumped
- High-quality material executions

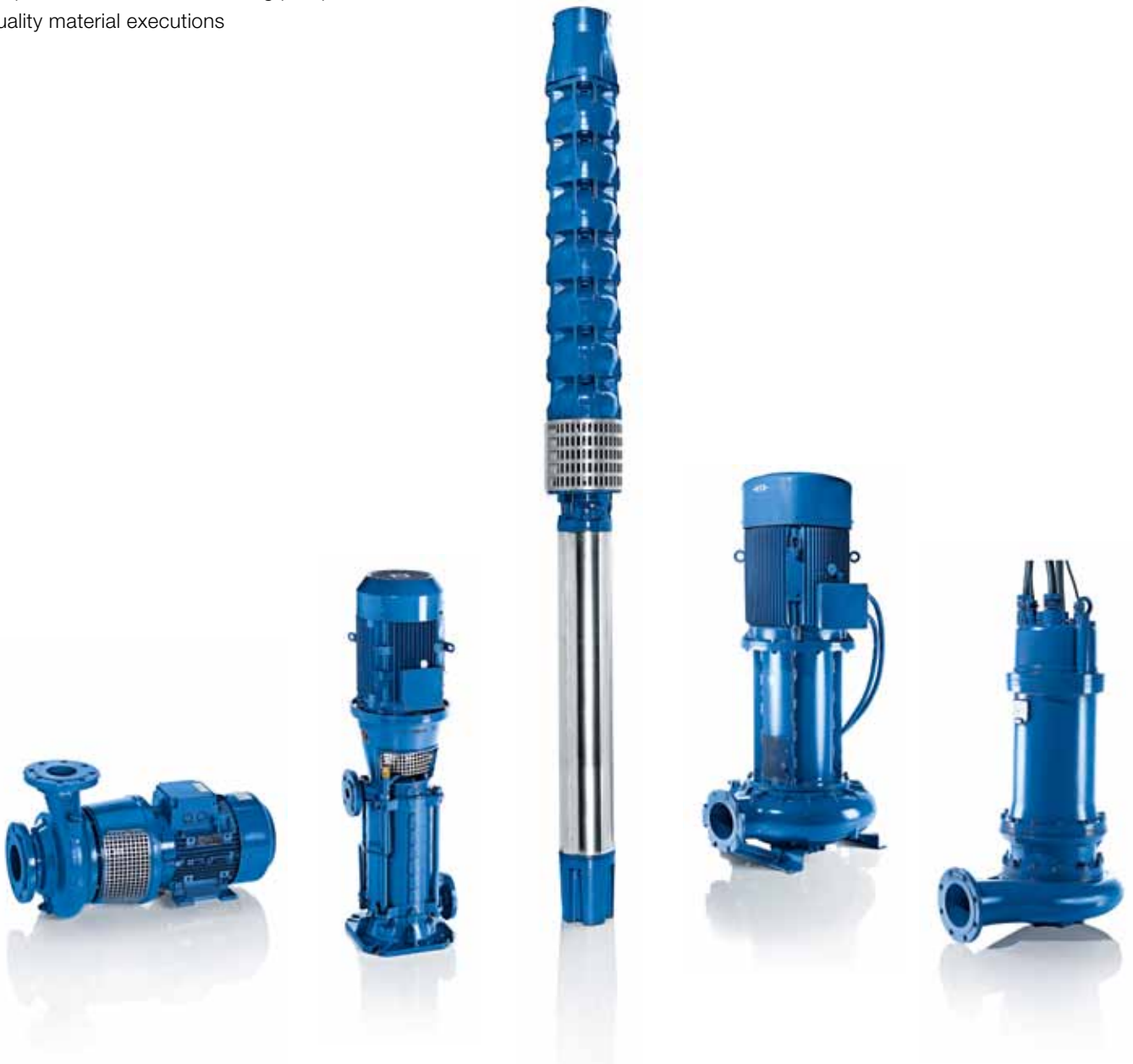

The product range for industry – an overview

	ES	HP	SU	SD	SW
Type	End suction pumps	High-pressure pumps	Submersible motor pumps	Sewage dry pumps	Sewage wet pumps
Design	01 03 04	45 46 49 55	56 62 63 64 66	15 35 38 39	22 26 59
Q	up to 4,000 m ³ /h	up to 800 m ³ /h	up to 500 m ³ /h	up to 10,000 m ³ /h	up to 2,600 m ³ /h
H	up to 100 m	up to 400 m	up to 700 m	up to 100 m	up to 80 m
p	up to 16 bar	up to 40 bar	up to 100 bar	up to 15 bar	up to 10 bar
t	up to +140°C	up to +140°C	up to +75°C	up to +140°C	up to +40°C
n	up to 3 600 rpm	up to 3 600 rpm	up to 3 600 rpm	up to 3 600 rpm	up to 3 600 rpm
Materials	grey cast iron, bronze, ductile iron, stainless steel	grey cast iron, bronze, aluminium bronze, stainless steel	grey cast iron, bronze, aluminium bronze, stainless steel * An ideal drive for the SUs are the SM sub- mersible motors. More information on these is available on page 20.	grey cast iron, stainless steel	grey cast iron, stainless steel

14 ES. End suction pumps

15 HP. High-pressure pumps

16 SU. Submersible motor pumps

22 SD. Sewage dry pumps

23 SW. Sewage wet pumps

Pumps for sewage

ANDRITZ Ritz pumps for sewage pumping plants and stations

- Cost-effective solutions for any structure
- Maintenance-friendly solutions for installation in dry and wet locations
- Non-clogging pumps with large free passages
- Numerous designs
- Long service life
- Design according to ATEX
- Special materials available

ANDRITZ Ritz pumps for sand trapping, sewage transport in sewage treatment plants and sludge pumping up to 10 % DS

- Wear-resistant designs
- Rugged construction
- Small to large capacities and heads
- Long service life



The product range for sewage – an overview

	SD	SW
Type	Sewage dry pumps	Sewage wet pumps
Design	15 35 38 39	22 26 59
Q	up to 10,000 m ³ /h	up to 2,600 m ³ /h
H	up to 100 m	up to 80 m
p	up to 15 bar	up to 10 bar
t	up to +140°C	up to +40°C
n	up to 3 600 rpm	up to 3 600 rpm
Materials	grey cast iron, stainless steel	grey cast iron, stainless steel

ES. End suction pumps



ES Design: 03 | Norma

DN 32 up to 150
Q up to 600 m³/h
H up to 100 m
p up to 16 bar
t -20°C up to +140°C
n up to 3600 rpm

Type: Single-stage volute casing pumps with principal dimensions and performance chart according to DIN EN 733.

Areas of use: Water supply and industry.

Media: Pure, slightly polluted and aggressive liquids with a viscosity of up to 150 mm²/s without abrasive and solid components.

Special feature: Maintenance-friendly. Removal of rotor unit with pump casing in situ.

Materials: grey cast iron, bronze, ductile iron, stainless steel

Shaft seal: gland packing, mechanical seal

Impeller design: radial impeller, vortex impeller and double-channel impeller available in some cases

Types of installation: A, E, B, S, V, VD, VDK

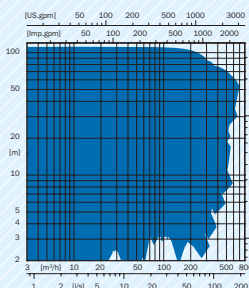

ES Design: 01 | Norma supplement

DN 150 up to 500
Q up to 4,000 m³/h
H up to 100 m
p up to 16 bar
t -20°C up to +140°C
n up to 1800 rpm

Type: Single-stage volute casing pumps.

Areas of use: Water supply and industry.

Media: Pure, slightly polluted and aggressive liquids with a viscosity of up to 150 mm²/s without abrasive and solid components.

Special feature: Maintenance-friendly. Removal of rotor unit with pump casing in situ.

Materials: grey cast iron, bronze, ductile iron, stainless steel

Shaft seal: gland packing, mechanical seal

Impeller design: radial impeller, semi-axial impeller

Types of installation: A, E, S, V, VD

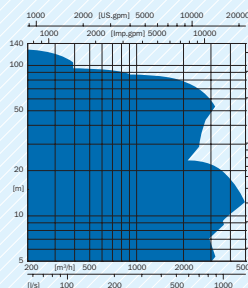

ES Design: 04 | RITZBloc

DN 25 up to 150
Q up to 550 m³/h
H up to 95 m
p up to 16 bar
t -20°C up to +140°C
n up to 3600 rpm

Type: Single-stage volute casing pumps in space-saving close-coupled design.

Areas of use: Water supply and industry.

Media: Pure, slightly polluted and aggressive liquids with a viscosity of up to 150 mm²/s without abrasive and solid components.

Special feature: Maintenance-friendly. Removal of rotor unit with pump casing in situ.

Materials: grey cast iron, bronze, ductile iron, stainless steel

Shaft seal: mechanical seal

Impeller design: radial impeller, vortex impeller and double-channel impeller available in some cases

Types of installation: BS, B, S

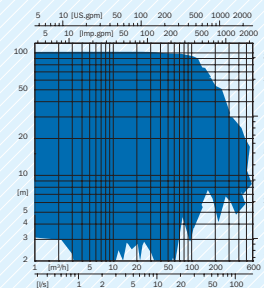

ASC. Axial split case pumps

HP. High-pressure pumps



ASC

Design: 07 | ASC

DN 150 up to 350
 Q up to 4,200 m³/h
 H up to 150 m
 p up to 25 bar
 t up to +110°C
 n up to 1 800 rpm

Type: Single-stage, axial split volute casing pumps.

Areas of use: Water supply.

Media: Pure, slightly polluted or aggressive liquids with a viscosity of up to 150 mm²/s without abrasive and solid components.

Special feature: Casing in in-line design. With horizontal installation, the motor can be placed on the left or right as desired.

Materials: grey cast iron, ductile iron, duplex stainless steel

Shaft seal: gland packing, mechanical seal

Impeller design: double-flow radial impeller with optimised suction characteristics and extraordinary NPSH values

Types of installation: A, E, S

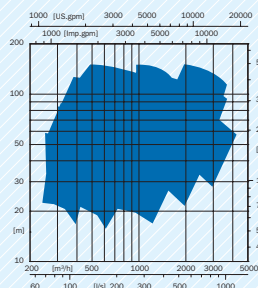

HP

Design: 55

DN 25 up to 80
 Q up to 70 m³/h
 H up to 280 m
 p up to 30 bar
 t 0°C up to +90°C
 n up to 3 600 rpm

Type: Multi-stage high-pressure pumps in in-line design.

Areas of use: Water supply, mining and industry.

Media: Pure and slightly polluted liquids.

Special feature: With round flanges or oval flanges with internal thread.

Materials: grey cast iron, stainless steel

Shaft seal: mechanical seal

Impeller design: radial impeller

Types of installation: S

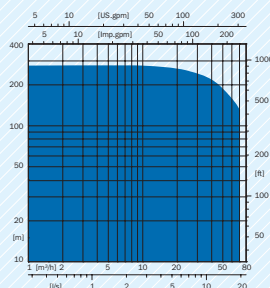

HP

Design: 45 | 46 | 49

DN 32 up to 250
 Q up to 800 m³/h
 H up to 400 m
 p up to 40 bar
 t -20°C to +140°C
 n up to 3 600 rpm

Type: Multi-stage high-pressure pumps.

Areas of use: Water supply, mining and industry.

Media: Clean and slightly polluted liquids with a viscosity of up to 150 mm²/s without abrasive and solid components.

Materials*: grey cast iron, bronze, aluminium bronze, stainless steel

Shaft seal: gland packing, mechanical seal

Impeller design: radial impeller

Types of installation*: A, AX, E, EX, S, V

* depends on design

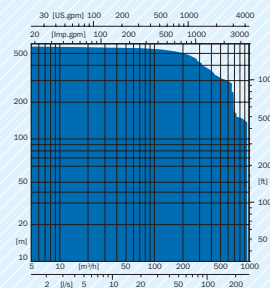

SU. Submersible motor pumps



SU Design: 56

Well Ø 6" and up
Q up to 150 m³/h
H up to 500 m
p up to 50 bar
t up to +40°C
n up to 3 600 rpm

Type: Multi-stage, single-suction submersible motor pumps with integrated check valve.

Areas of use: Water supply, mining and industry.

Media: Pure, slightly polluted and aggressive clean, service and cooling water.

Materials: stainless steel

Shaft seal: mechanical seal

Impeller design: radial impeller, semi-axial impeller

Types of installation: U (vertical, horizontal)

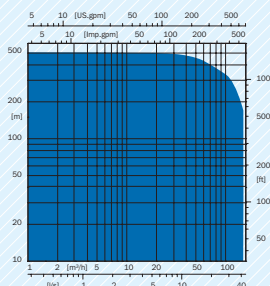

SU Design: 62 | U8

Well Ø 8" and up
Q up to 145 m³/h
H up to 650 m
p up to 63 bar
t up to +75°C
n up to 3 600 rpm

Type: Multi-stage, single-suction submersible motor pumps with integrated check valve.

Areas of use: Water supply, mining and industry.

Media: Pure, slightly polluted and abrasive raw water, pure water, mineral water, seawater, service water, mine water and cooling water.

Materials: grey cast iron, aluminium bronze

Shaft seal: mechanical seal, shaft sealing ring

Impeller design: semi-axial impeller

Types of installation: U (vertical, horizontal)

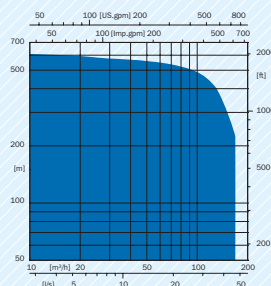

SU Design: 63 | 64 | 66

Well Ø 10" and up
Q up to 500 m³/h
H up to 700 m
p up to 100 bar
t up to +75°C
n up to 3 600 rpm

Type: Multi-stage, single-suction submersible motor pumps.

Areas of use: Water supply, mining and industry.

Media: Pure, slightly polluted and abrasive raw water, pure water, mineral water, seawater, service water, mine water and cooling water.

Materials: grey cast iron, aluminium bronze

Shaft seal: mechanical seal, shaft sealing ring

Impeller design: semi-axial impeller

Types of installation: U (vertical, horizontal)

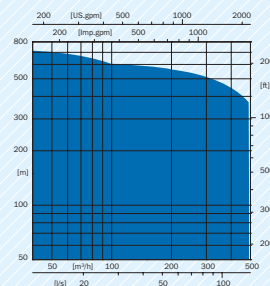

MS-T. Modular Shaft Technology

Designed to save costs

The challenge.

More and more, the cost-effectiveness of an application is becoming the decisive criteria for any investment. This raises the question as to whether the concept of the continuous shaft is still up to date. For example, assembly and disassembly of a pump with a continuous shaft requires a large number of individual steps – time-consuming work by an expert! Logistics and warehousing for numerous different component parts is also associated with high costs. Adaptation to changing heads is generally only possible by replacing the pump – a cost-intensive procedure. The problem is obvious. But so is the solution!

The solution.

MS-T – Modular Shaft Technology is not only a technological evolution, but also a revolution when it comes to costs.

MS-T is designed according to the modular principle – with all of its technical and economic advantages.

- Flexible adaptation to changing pumping conditions – quick and easy by increasing or reducing the number of stages.
- Simple, time-saving and targeted installation and removal of individual stages, horizontal or vertical as desired.
- A small number of highly-standardised components guarantees high availability
- and short delivery times, as well as low warehousing costs on the part of the user.

That is why pumps with MS-T are the perfect solution wherever extremely high demands are placed with regard to operational reliability, freedom from maintenance, service life, efficiency and flexible heads. In all sectors of water supply, mining and industry.



**Complete information is available in our brochure “MS-T – Modular Shaft Technology”, which we would be happy to send you on request.
Phone +49 (0)7171 609 0 or under www.andritz.com**

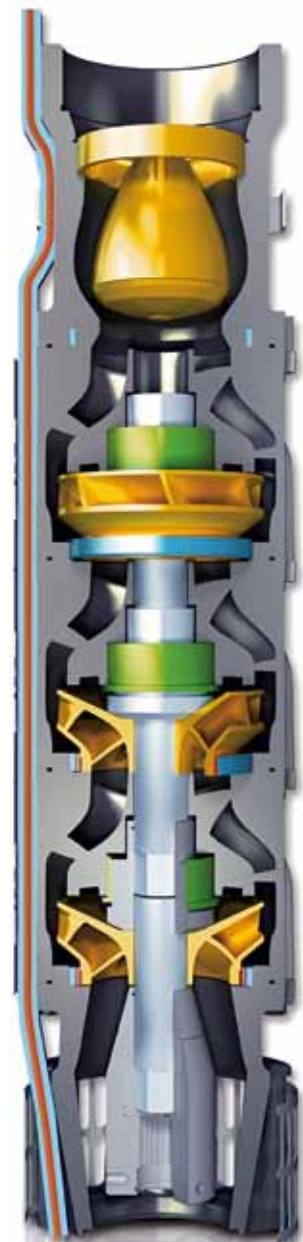

HDM. Double-suction submersible motor pumps



Maximum operational reliability.

Constant performance – error-free operation: An HDM invented by ANDRITZ Ritz guarantees maximum operational reliability with no compromises.



HDM

Design: 61 | 67 | 68

- Well Ø 20" and up
- Q up to 6,000 m³/h
- H up to 1,500 m
- p up to 150 bar
- t up to +75°C
- n up to 3600 rpm

Type: Multi-stage, double-suction submersible motor pumps.

Areas of use: Mining, water supply and industry.

Media: Pure, slightly polluted and abrasive raw water, pure water, mineral water, seawater, service water, mine water and cooling water.

Special feature: Axial thrust free, double-suction design for particularly long service life and high operational reliability.

Materials: grey cast iron, bronze, aluminium bronze, duplex stainless steel

Shaft seal: mechanical seal, shaft sealing ring

Impeller design: radial impeller

Types of installation: U (vertical, horizontal)

High cost-effectiveness.

Extremely high efficiency in operation – up to more than 85 % for the pump, up to more than 90 % for the motor – as well as extraordinarily long service life ensure minimum life-cycle costs, which are more decisive than the procurement costs in the long term.

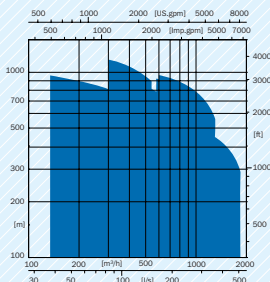

HDM. Heavy Duty Mining

Designed for a longer life

The challenge.

The use of submersible motor pumps for large volumes or at very large depths is associated with extreme loads on the unit. The higher the pump capacity, the stronger the axial thrust exerted on the pump, the motor and its thrust bearing. The outcome: Overloading and increased risk of failure.

The solution.

HDM – Heavy Duty Mining. Two pumps are arranged on top of each other rotating in opposite directions and driven by a continuous pump shaft.

The division of work between the two pumps provides complete compensation of axial thrust, thus solving the problems of forces acting on the unit and of the load on the thrust bearing. At the same time, the flow and suction velocity outside the pump is reduced by 50%. This is more gentle on the well walls around the intake openings and minimises the intake of abrasive substances.

The result.

Besides the technical advantages – complete compensation of axial thrust, 50% lower flow velocity and smaller-diameter impellers – HDM also provides economic benefits: maximum operational reliability, minimum wear and extremely long service life, which can quite often exceed 20 years. Paired with the ideal drive – the ANDRITZ Ritz high-performance submersible motor – an unbeatable team!

Custom-tailored solutions.

Each ANDRITZ Ritz submersible motor pump with HDM technology is a custom-made item. It is individually configured to suit your requirements.

**Complete information is available in our brochure “HDM – Heavy Duty Mining”, which we would be happy to send you on request.
Phone +49 (0)7171 609 0 or under www.andritz.com**



SM. Submersible motors



SM

Low-voltage motor

Well Ø 8" and up
P up to 700 kW
V up to 1,000 volts
t up to +75°C
n up to 3 600 rpm

Type: Water-filled and cooled three-phase asynchronous motor with squirrel-cage rotors.

Areas of use: Water supply, mining and industry.

Special feature: With rewindable winding.

Materials: grey cast iron, bronze, stainless steel

Shaft seal: mechanical seal, shaft sealing ring

Types of installation: vertical, in some cases horizontal

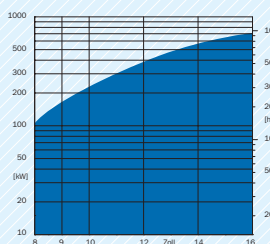

SM

High-voltage motor

Well Ø 10" and up
P up to 5,000 kW
V up to 14,000 volts
t up to +75°C
n up to 3 600 rpm

Type: Water-filled and cooled three-phase asynchronous motor with squirrel-cage rotors.

Areas of use: Water supply, mining and industry.

Special feature: With rewindable winding.

Materials: grey cast iron, bronze, stainless steel

Shaft seal: mechanical seal, shaft sealing ring

Types of installation: vertical, in some cases horizontal

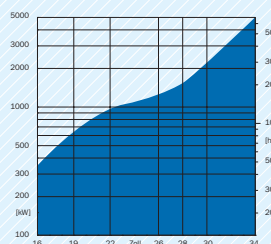

MC-T. Modular Cooling Technology

Designed for highest temperatures

The challenge.

The efficient and cost-effective cooling of submersible motors has long been a hot topic among operators of wells and mines. “Derating” was, and still is, a makeshift solution. But besides the higher investment and energy costs, these oversized, derated motors generally require a larger well diameter. Oil cooling is also questionable in many ways – any defects pose the risk of devastating ecological consequences.

The solution.

MC-T – Modular Cooling Technology, an intelligent, compact cooling system that lays all of these questions to rest. Here a pump impeller creates motion in the cooling circuit, ensuring flow in the proper direction. Cooling channels developed in-house by us guarantee heat absorption from all of the thermal sources, ensure evacuation, and provide optimal heat transmission via the outer wall of the motor to the medium being pumped. The cooling performance can be dimensioned precisely through the use of additional heat-exchanger modules.

Technical details and economic advantages.

- Media temperatures up to 75°C
- High efficiency over the entire performance range
- Use of drinking water as the cooling fluid
- Low investment costs
- Reduced energy costs
- Maximum operational reliability
- Long service life

**Complete information is available in our brochure “MC-T – Modular Cooling Technology”, which we would be happy to send you on request.
Phone +49 (0)7171 609 0 or under www.andritz.com**



SD. Sewage dry pumps



SD Design: 35 | AS

DN 65 up to 250
Q up to 1,400 m³/h
H up to 100 m
p up to 10 bar
t -20°C to +140°C
n up to 3 600 rpm

Type: Single-stage channel impeller pumps.

Areas of use: Sewage and industry.

Media: Low/high viscosity and abrasive media and sludges with or without gas content.

Special feature: Maintenance-friendly. Removal of rotor unit with pump casing in situ.

Material: grey cast iron

Shaft seal: mechanical seal

Impeller design: single-channel impeller, double-channel impeller, vortex impeller

Types of installation: A, E, HZ, SL, SG

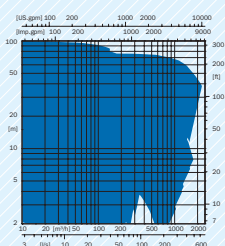

SD Design: 38

DN 80 up to 250
Q up to 1,400 m³/h
H up to 90 m
p up to 15 bar
t -20°C to +140°C
n up to 3 600 rpm

Type: Single-stage channel impeller pumps.

Areas of use: Sewage and industry.

Media: Low/high viscosity and abrasive media and sludges with or without gas content as well as quench water.

Special feature: Maintenance-friendly. Removal of rotor unit with pump casing in situ.

Material: grey cast iron, stainless steel

Shaft seal: gland packing, mechanical seal

Impeller design: single-channel impeller, double-channel impeller, vortex impeller

Types of installation: A, AL, E, H, HL, HZ, H with stub shaft, K, B, S, SL, SG, V, VD

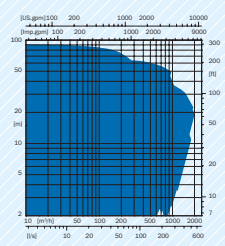

SD Design: 39

DN 200 up to 500
Q up to 4,800 m³/h
H up to 40 m
p up to 10 bar
t -20°C to +140°C
n up to 1 800 rpm

Type: Single-stage channel impeller pumps.

Areas of use: Sewage and industry.

Media: Low/high viscosity and abrasive media, such as screened sewage, sludges without gas content, and quench water.

Special feature: Maintenance-friendly. Removal of rotor unit with pump casing in situ.

Material: grey cast iron, ductile iron

Shaft seal: gland packing, mechanical seal

Impeller design: multi-channel "T"-type impeller, double-channel impeller

Types of installation: A, E, H, HZ

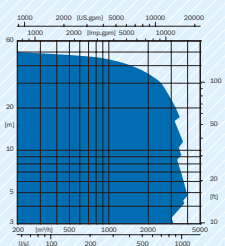

SD Design: 15

DN 600
Q up to 4,000 m³/h
H up to 15 m
p up to 2.5 bar
t -20°C to +70°C
n up to 1 000 rpm

Type: Single-stage mixed flow pumps.

Areas of use: Sewage and industry.

Media: Pure, slightly polluted or heavily polluted liquids with occasional solid debris.

Special feature: Maintenance-friendly. Removal of rotor unit with pump casing in situ.

Material: grey cast iron

Shaft seal: gland packing, mechanical seal

Impeller design: mixed flow impeller

Types of installation: A, E, HZ, H with stub shaft, S, V

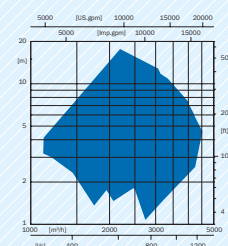

SW. Sewage wet pumps



SD

Design: 35 | AS supplement

DN 350 up to 700
Q up to 10,000 m³/h
H up to 50 m
p up to 10 bar
t -20°C to +60°C
n up to 1000 rpm

Type: Single-stage channel impeller pumps.

Areas of use: Sewage and industry.

Media: Low/high viscosity and abrasive media and sludges with or without gas content.

Special feature: Maintenance-friendly. Removal of rotor unit with pump casing in situ.

Material: ductile iron

Shaft seal: mechanical seal

Impeller design: multi-channel "T"-type impeller

Types of installation: BS

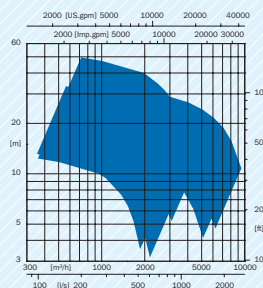

SW

Design: 22, 26 | AT, ATL

DN 65 up to 400
Q up to 2,600 m³/h
H up to 80 m
p up to 10 bar
t up to +40°C
n up to 3 600 rpm

Type: Single-stage submersible pumps in close-coupled design.

Areas of use: Sewage and industry.

Media: Sewage and waste water as well as sludges with a solids content of up to 10%.

Special feature: Pumps are also available in an explosion-proof design.

Material: grey cast iron, stainless steel

Shaft seal: mechanical seal

Impeller design: single-channel impeller, double-channel impeller, vortex impeller

Types of installation: N, M, TV, TH

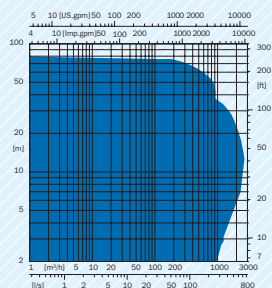

SW

Design: 59 | ETS, ETL

R 1 1/2" – 4"
Q up to 100 m³/h
H up to 22 m
p up to 10 bar
t up to +40°C
n up to 3 600 rpm

Type: Single-stage submersible drainage pumps in close-coupled design.

Areas of use: Sewage and industry.

Media: Pure to slightly polluted liquids without coarse debris.

Special feature: Available with float switch.

Material: stainless steel, grey cast iron

Shaft seal: mechanical seal

Impeller design: vortex impeller

Types of installation: M

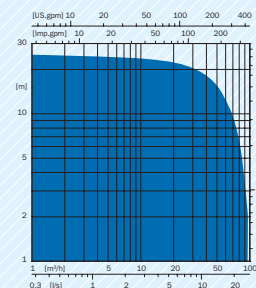

Types of installation

Every ANDRITZ Ritz pump can be supplied for various types of installation. The choice of the appropriate installation type depends

on your specific application. The available types of installation are shown in the corresponding line in the product descriptions.

A, AL, AX

Pumps with bare shaft end.
Installation: dry, horizontal.

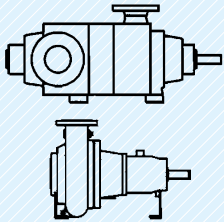

H, HL

Pumps with V-belt drive. Motor is mounted on bearing bracket.
Installation: dry, horizontal.

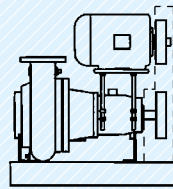

K

Pumps with V-belt drive.
Motor is mounted alongside pump on slide rails.
Installation: dry, horizontal.

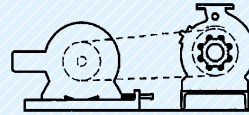

SG

Pumps for cardan shaft drive.
Installation: dry, vertical.

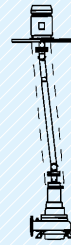

BS

Pumps with directly coupled special motor (close-coupled design).
Installation: dry, horizontal or vertical.

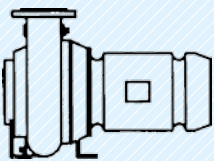

HZ

Pumps with V-belt drive. Motor is mounted on a support frame.
Installation: dry, horizontal.

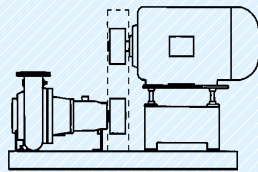

B

Pumps with directly coupled standard IEC motor (close-coupled design).
Installation: dry, horizontal.

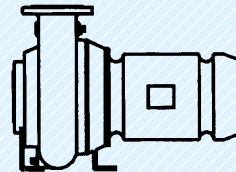

SL

Pumps with flexibly coupled motor.
Installation: dry, vertical.

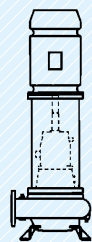

E, EX

Pumps with flexibly coupled motor.
Installation: dry, horizontal.

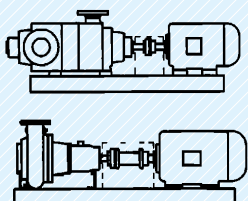

H with stub shaft

Pumps with V-belt drive and stub shaft. Motor is mounted on a support frame.
Installation: dry, horizontal.

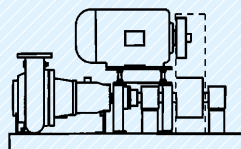

S

Pumps with directly coupled standard IEC motor (close-coupled design).
Installation: dry, vertical.



M

Pumps with directly coupled submersible motor.
Installation: wet, vertical, mobile.

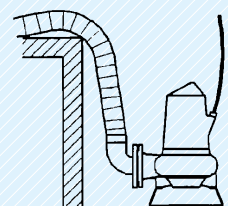

N

Pumps with directly coupled submersible motor.

Installation: wet, vertical, stationary.

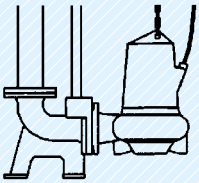
**U**

Pumps with directly coupled submersible motor.

Installation: wet, vertical or horizontal, optionally in pipe shroud for dry installation.

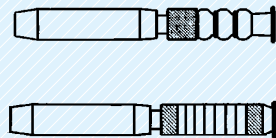
**TH**

Pumps with directly coupled submersible motor.

Installation: dry, horizontal.

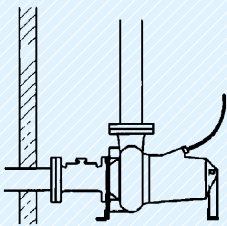
**V**

Pumps with drive via supporting tube system. Motor is fastened above floor level on a motor stool.

Installation: dry or wet, vertical.

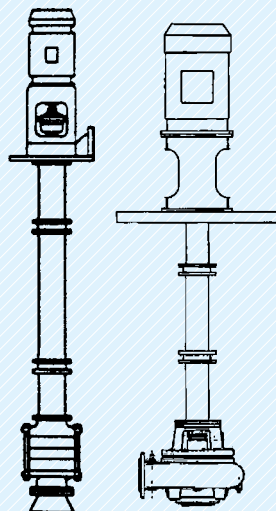
**VD**

Pumps with drive via supporting tube system. Larger base plate with lateral delivery pipe. Motor is fastened above floor level on a motor stool.

Installation: dry or wet, vertical.

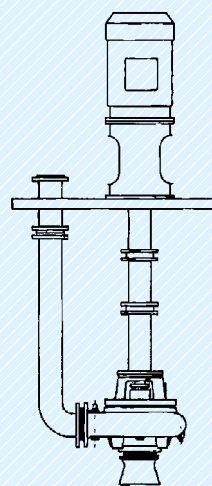
**VDK**

Pumps with drive via extended pump shaft. Optionally with larger base plate and lateral delivery pipe. Motor is fastened above floor level on a motor stool.

Installation: wet, vertical.

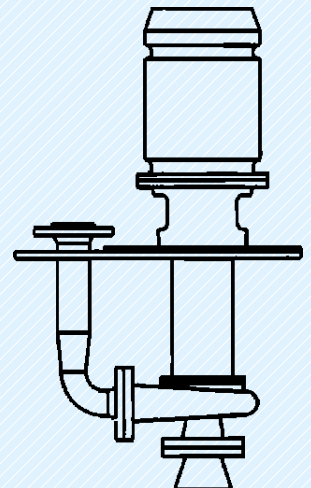
**TV**

Pumps with directly coupled submersible motor.



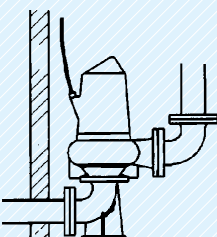





Installation: dry, vertical.

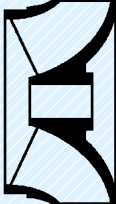

ANDRITZ Ritz impellers

Selection of the correct impeller is a prerequisite for reliable operation of ANDRITZ Ritz pumps. This chart shows you which ANDRITZ Ritz impeller is most suitable for which media, as well

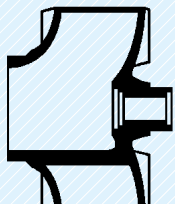
as their specific functional features. To see which ANDRITZ Ritz pumps can be supplied with which impellers, please refer to the corresponding line in the product descriptions.

<p>Shrouded Radial impeller</p>	<p>Special features: Maximum heads at low capacities. Very good efficiencies over a wide flow range.</p> <p>Media: Pure to slightly polluted liquids.</p>		
<p>Shrouded Mixed flow impeller</p>	<p>Special features: For high heads at average capacities. Very good efficiencies over a wide flow range.</p> <p>Media: Pure to slightly polluted liquids.</p>		
<p>Vortex impeller</p>	<p>Special features: Virtually non-clogging thanks to large free passages.</p> <p>Media: For high air and gas content liquids, stringy or matting materials and sludges and abrasive debris. For example: Raw sewage, rainwater, primary sludge.</p>		
<p>Single-channel impeller</p>	<p>Special features: Large free passages for gentle pumping of sensitive solid components. Virtually non-clogging!</p> <p>Media: For media with coarse, stringy and matting debris. For example: Raw sewage, raw sludge, return activated sludge, excess sludge.</p>		

Double-channel impeller

Special features: Quiet operation thanks to symmetrical shape.

Media: For sludges and suspensions of solids with coarse debris without stringy fibrous materials, gases or air inclusions. For example: Screened sewage, activated sludge, excess sludge.



Multi-channel "T"-type impeller

Special features: Quiet operation and stable, evenly descending Q/H curves.

Media: For media with coarse, stringy and matting debris. For example: Raw sewage, raw sludge, return activated sludge, excess sludge.

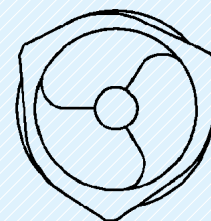

Multi-channel impeller

Special features: Quiet operation and good efficiency.

Media: For slightly polluted and sludgy media without stringy fibrous materials, gases or air inclusions and for suspensions with up to 3% of dry substance. For example: Rainwater, screened sewage, activated sludge.

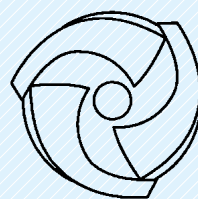

Open mixed flow impeller

Special features: For large capacities at relatively low heads. Minimum risk of clogging thanks to large free passages.

Media: For pure and polluted liquids containing solids and/or gas, without any stringy or matting debris. For example: Rainwater, screened sewage, activated sludge.



WinPump

For selecting and dimensioning

- WinPump is the original! ANDRITZ Ritz was the first to launch a software for pump selection and configuration. You, too can benefit from our edge in know-how: With WinPump!
- Our complete product range! It's all in there – everything from standard pumps, high-pressure pumps and submersible motor pumps to sewage pumps.
- For all areas of expertise! Impressive results in the fields of water, mining, industry and sewage.
- Hydraulic selection! Your customised solution is only a few clicks away.
- An extensive range of functions and highly-detailed adaptation to the operating conditions.
- Simple configuration and user-friendly operation! With WinPump you can work faster, more independently and more professionally.

System requirements

128 MB RAM, Pentium III | Windows 95 or Windows NT 4.0 with SP 6a or higher |
Approx. 50 MB of free hard disk space | The requirements for RAM and the hard disk
are highly dependent on the size of the database, and may therefore vary in some cases.

For more detailed information

We have prepared detailed technical information for all ANDRITZ Ritz products. You can order this information from us either by phone, by fax at +49 (0)7171 609 287 or simply over the internet at www.andritz.com.

When ordering by fax, simply copy the form below and check the boxes for the information you require.

Last name | First name

.....

Company

.....

Branch of industry

.....

Department

.....

Street | No.

.....

Post code | City/town

.....

Country

.....

Phone

.....

Fax

.....

E-Mail

.....

- ES. End suction pumps
- ASC. Axial split case pumps
- HP. High-pressure pumps
- SU. Submersible motor pumps
- MS-T. Modular Shaft Technology
- HDM. Heavy Duty Mining
- SM. Submersible motors
- MC-T. Modular Cooling Technology
- SD. Sewage dry pumps
- SW. Sewage wet pumps
- WinPump. Free of charge.

Close to our customers

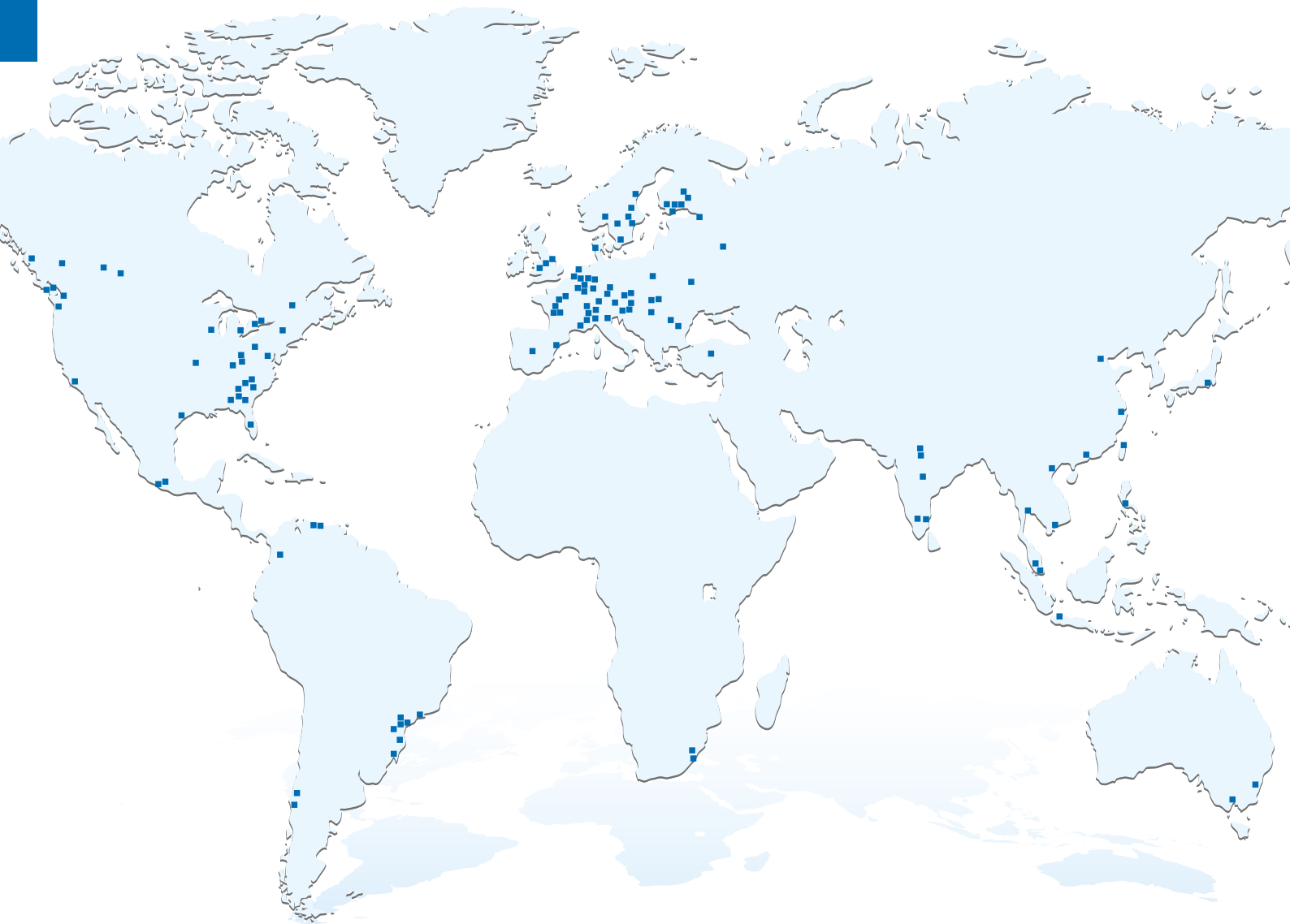

ANDRITZ Ritz GmbH
Güglingstraße 50
73529 Schwäbisch Gmünd, Germany
Phone: +49 (0)7171 609 0
Fax: +49 (0)7171 609 287
ritz@andritz.com



www.andritz.com