

GRUNDFOS
SP ENGINEERING MANUAL



1 Introduction

2 Water supply

2.1 Resources 9

2.2 Groundwater 9

2.2.1 Groundwater wells 9

2.2.2 Riverbank filtration 9

2.2.3 Groundwater requirement 10

2.2.4 Required raw/well water and water treatment capacity 11

2.2.5 Well yield and operational efficiency 12

2.3 Surface water 14

2.3.1 From fresh water sources 14

2.3.2 From the sea and saltwater sources 14

3 Applications

3.1 Freshwater supply 17

3.2 Dewatering 19

3.2.1 Mining 19

3.3 Horizontal application 20

3.4 Air/gas in water 20

3.5 Corrosive water (seawater) 22

3.6 Hot water and geothermal water 23

3.7 Booster modules 24

4 Pumps

4.1 Pump principle 27

4.2 Wear parts 28

4.3 Pump selection 28

4.4 Pump curves and tolerances 29

5 Motors and controls

5.1 Motor types, general description 33

5.2 Motor cables and joints, reference to drop cables 35

5.3 Motor protection devices 36

5.4 Reducing the locked-rotor current 36

5.4.1 Direct-on-line – DOL 37

5.4.2 Star-delta – SD 38

5.4.3 Autotransformer – AT 39

5.4.4 Primary resistor-type starter, RR 39

5.4.5 Soft starter – SS 39

5.4.6 Frequency converters (variable speed drive) 40

5.5 Operation with frequency converter 41

5.6 CUE variable speed drive for SP pumps 43

6 Power supply

6.1 Power generation 47

6.2 Voltage 47

6.2.1 Voltage unbalance 47

6.2.2 Overvoltage and undervoltage 47

6.3 Frequency 48

6.4 Variable frequency drives 48

6.5 Grid connection 49

6.6 Current asymmetry 50

7 Installation & operation

7.1 Wells and well conditions 55

7.2 Pump setting 56

7.3 Pump and motor selection 56

7.3.1 The duty point 56

7.3.2 Well diameter 57

7.3.3 Well yield 57

7.3.4 Pump efficiency 57

7.3.5 Water temperature 60

7.3.6 Derating of submersible motor 60

7.3.7 Protection against boiling 61

7.3.8 Sleeve cooling 61

7.4 Riser pipe selection 62

7.5 Cable selection and sizing 63

7.6 Handling 65

7.6.1 Pump / motor assembly 65

7.6.2 Cable splice/Connection of motor cable and drop cable 65

7.6.3 Riser pipe connections 66

7.7 Pumps in parallel operation 66

7.8 Pumps in series operation 66

7.9 No. of start/stops 67

7.10 Pump start up 67

7.11 VFD operation 67

7.12 Generator operation 67

8 Communication

8.1 General introduction 71

8.2 Communications and Networking Technology 71

8.3 SCADA systems 72

8.3.1 SCADA main parts 72

8.3.2 SCADA functions 72

8.3.3 Web-hosted SCADA 73

8.4 Networking basics 74

8.4.1 Networking topology 74

8.4.2 Communications protocol 75

8.4.3 Functional profile 75

8.4.4 The fieldbus 75

8.5 GENIbus 76

8.5.1 Background 76

8.5.2 Technical description 76

8.5.3 Cabling guidelines 77

8.6 Grundfos GENIbus products for SP Applications 78

9 Troubleshooting

9 Troubleshooting 81

10 Accessories

10.1 Cooling sleeves 83

10.2 Corrosion protection in seawater 83

10.2.1 Cathodic protection 83

10.2.2 Galvanic cathodic protection systems 83

10.2.3 Impressed current cathodic protection systems 84

10.3 Drop cables 84

10.4 Cable joints 85

10.5 Riser pipes 85

11 Additional information

11 Additional information 87

12 Index

12 index 88

Serving our common interests

This engineering manual has been created with a specific focus on one of Grundfos' most recognisable and popular pumps: the SP. When it was created in the late 1960's, this breakthrough product set new standards within durability, efficiency, and construction in thin-plate stainless steel. The numerous product types, sizes, and configuration possibilities available today serve as a testament to the innovative nature of the original SP pumps.

Working with SP pumps on a daily basis often gives rise to lots of different questions. We have created this engineering manual to help you quickly and easily find the answers to a number of these questions. We serve our common interests of providing the best possible SP solutions and service for all customers.

Please note that this engineering manual is a supplement to and not a replacement for product data booklets and installation manuals. The newest editions of these publications are always the most valid and must be adhered to.

We have taken considerable time and care to make the presentation as convenient and easy to use as possible. We realise, however, that there is always room for improvement, and invite you to comment. Please contact your local Grundfos representative if there are subjects you would like to see covered in future editions.

We sincerely hope that you find this manual a useful reference tool in your work with SP pumps.



Kenth H. Nielsen
Global program Director,
Grundfos Management A/S



2. Water Supply

2.1 Resources

The amount of water in the world is constant. It is changing position, quality, phase, etc., but it is constant. Seawater accounts for approx. 97.5% of all water. Fresh water accounts for the remaining 2.5%. Two-thirds of the fresh water is bound as glaciers, polar ice, and snow cover. The remaining, less than 1% of all water in the world, is somehow available in different sources for mankind to use.

These sources are:

- groundwater, shallow or deep underground aquifers of water
- surface water, from rivers or lakes.

In case no fresh water is available, seawater or contaminated water is treated and used as fresh water.

2.2 Groundwater

Groundwater is typically between 25 and 10,000 years old. Before it reaches the aquifer, it has been filtered and exposed to biological treatment on its way through the various layers of the ground. Groundwater is therefore usually of high quality and requires little or no treatment before it is consumed.

2.2.1 Groundwater wells

Irrigation and water supply systems serving up to 500,000 consumers and the adjacent industries are ideally supplied by groundwater. Pollution-free aquifers larger than 600 km² are normal. 75 to 150 well-intakes spread on the different aquifers will provide the most environmentally-friendly, safest and reliable water sources. For waterworks serving more than 1 million consumers, an additional source such as riverbank filtration, river dams, or desalination should be considered.

The individual wells are to be extended into older groundwater at pollution-free depths when extracting for drinking water. Irrigation wells can easily use water from the upper aquifer, the secondary aquifer, with slightly polluted water quality. The groundwater level will vary over the seasons, but is to be respected on the yearly basis, as the maximum removable quantity is similar to what is created every year.

If groundwater levels are permanently lowered, a water supply disaster with an increasing salinity and other undesired substances can be expected.

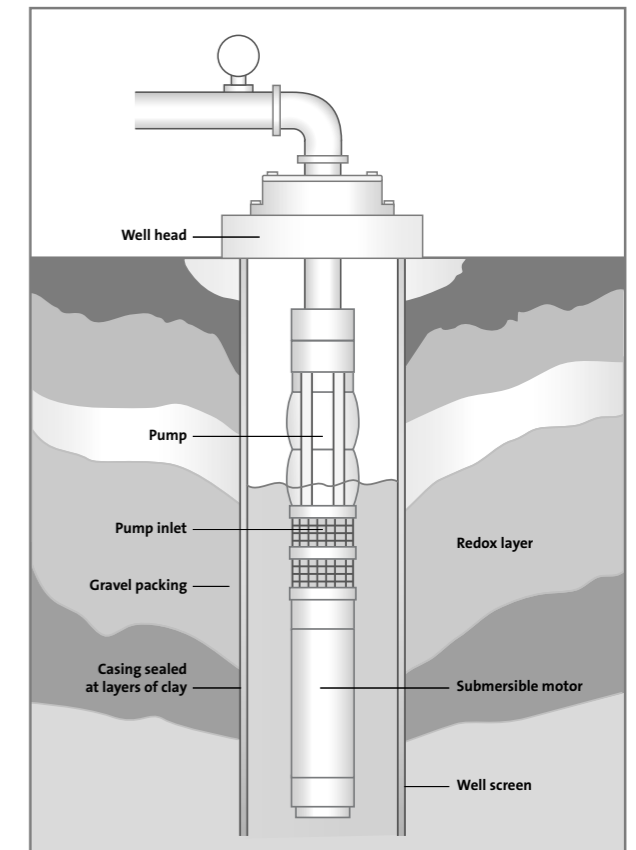

Fig. 1 Groundwater well with submersible pump

2.2.2 Riverbank filtration

In riverbank filtration wells, the well is placed nearby a river. Using this method, the river water is filtered through the ground. This process is a natural addition to a direct intake plant needing capacity enlargement. The easy-to-clean, pre-filtered water requires less final treatment and extracts water from the aquifer when the river level runs low.

After every wet period with high river water levels, the mud/dung/sediments of the riverbed are washed downstream and partly replaced by new sediments. This natural process provides perfect conditions for a 90% reduction of human-induced enzymes, viruses, bacteria, pathogens, and so on. Each wet period with high river water levels also fills the aquifers around the river with water, where it is stored and ready for

feeding the riverbank wells when the river water level runs low in dry season. The storage of river water in aquifers causes less water stress on the river during dry seasons.

Riverbank wells can be constructed like groundwater wells, or from 7-8m vertical casings dug down under the riverbed. They can be supplemented with 8-12 horizontal injected steel screens or filters for sediment-free water intake.

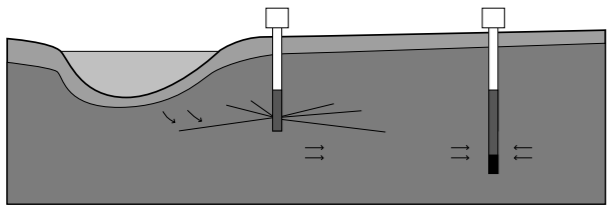

Fig. 2 Riverside well installations

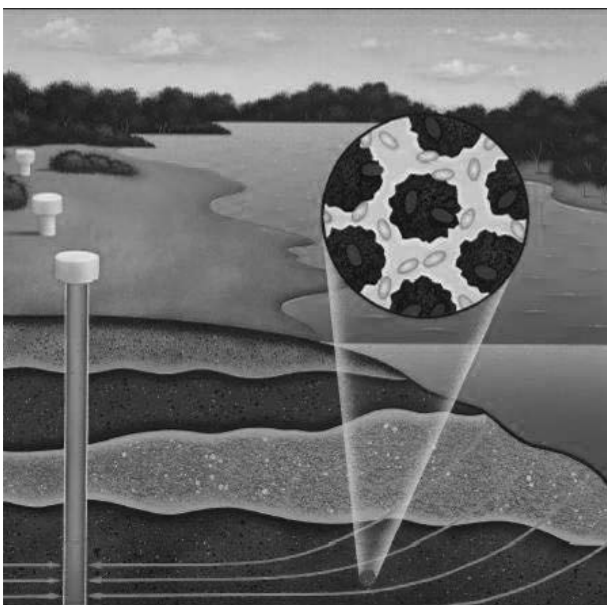

Fig. 3 Riverbank filtration
Bacteria, pathogens, etc. are trapped by the sediments.

2.2.3 Groundwater requirement

The basis for determining the groundwater requirement from the well fields is to evaluate the relationship between the water storage volume and the finished water production capacity compared to peak and daily consumption.

To find the peak hourly consumption, please refer to the MPC-Booster section of Grundfos WinCAPS/WebCAPS or figures 4 and 5.

Pump-out requirement

Water is used by many different types of consumers, each with a specific consumption pattern. There are many methods of calculating the maximum water requirement, both manual and computerised ones.

The table below can be used for rough calculation of the water requirement for:

- office buildings
- residential buildings incl. blocks of flats
- department stores
- hospitals
- hotels.

Category	Units	Average m ³ /h
Dwellings	2,000 units	70
Office buildings	2,000 employees	30
Department stores	2,000 employees	55
Hotels	1,000 beds	110
Hospitals	1,000 beds	80
Maximum peak load (warm season)		345

Factors for calculating daily consumption:

- Minimum 100 consumers connected: Factor 8
- Minimum 30 consumers connected: Factor 4
- Minimum 10 consumers connected: Factor 2.5

The maximum daily consumption in the example above will be factor 8 x 345 m³/h = 2,760 m³/day.

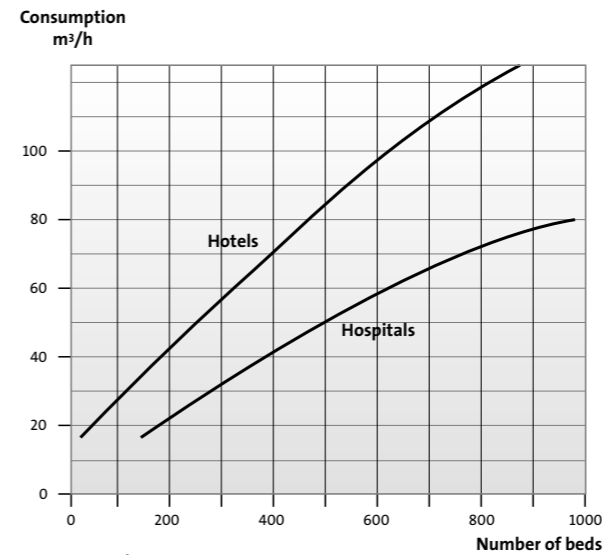

Fig. 4 Peak water consumption

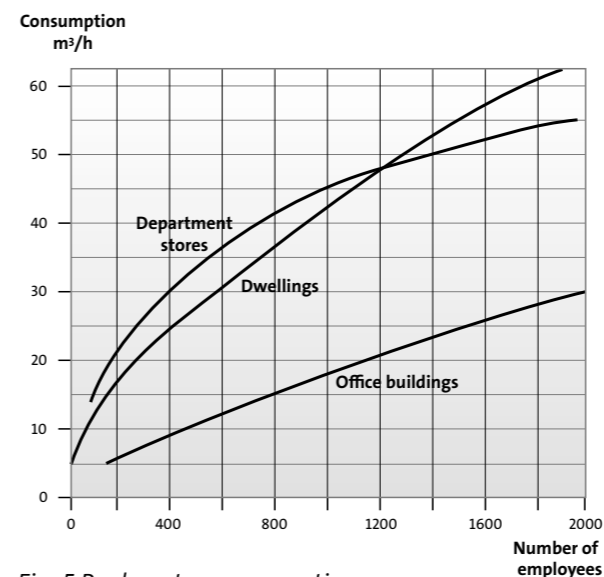

Fig. 5 Peak water consumption

Peak hourly consumption is stated, this can be converted into assumed daily consumption by using the factors 8/4/2.5.

2.2.4 Required raw/well water and water treatment capacity

The relationship between water storage and daily consumption illustrates the percentage of the daily consumption that is present in storage. With this percentage, follow it horizontally in fig. 6 to find the necessary percentage for raw-water requirement. The daily consumption multiplied by the percentage of raw-water requirement provides the necessary capacity from the well fields.

If a treatment plant has no cleanwater tank or water tower, the raw-water and treatment capacity must be equal to the maximum hourly consumption, i.e. $Q_{\text{raw-water}} = 345 \text{ m}^3/\text{h}$ in the example.

If the treatment plant has a clean-water tank or a water tower capacity of 2,760 m³, peak load situations can be covered from the reservoir. This means that the raw-water pumps can run constantly around the clock at $2,760/24 \text{ m}^3/\text{h} = 115 \text{ m}^3/\text{h}$.

The effective volume of the clean-water tank and/or water tower and the maximum capacity of the treatment plant are crucial for investment costs in connection with groundwater wells.

In the example, there is a clean-water tank of 1,600 m³. This means that the water reservoir comprises $1,600/2,760 \times 100 = 58\%$ of the daily consumption.

At a maximum peak consumption of 345 m³/h and a maximum consumption of 2,760 m³/day and with an effective clean-water tank volume of 1,600 m³, the raw-water capacity must be at least $2,760 \times 7.6/100 = 210 \text{ m}^3/\text{h}$. 7.6 is taken from fig. 2. This will give a maximum duty time of the raw-water pumps of $2,760/210 = 13 \text{ hours/day}$.

The 210 m³/h are split up between at least three to four wells. In case of fewer wells, a standby installation must be made.

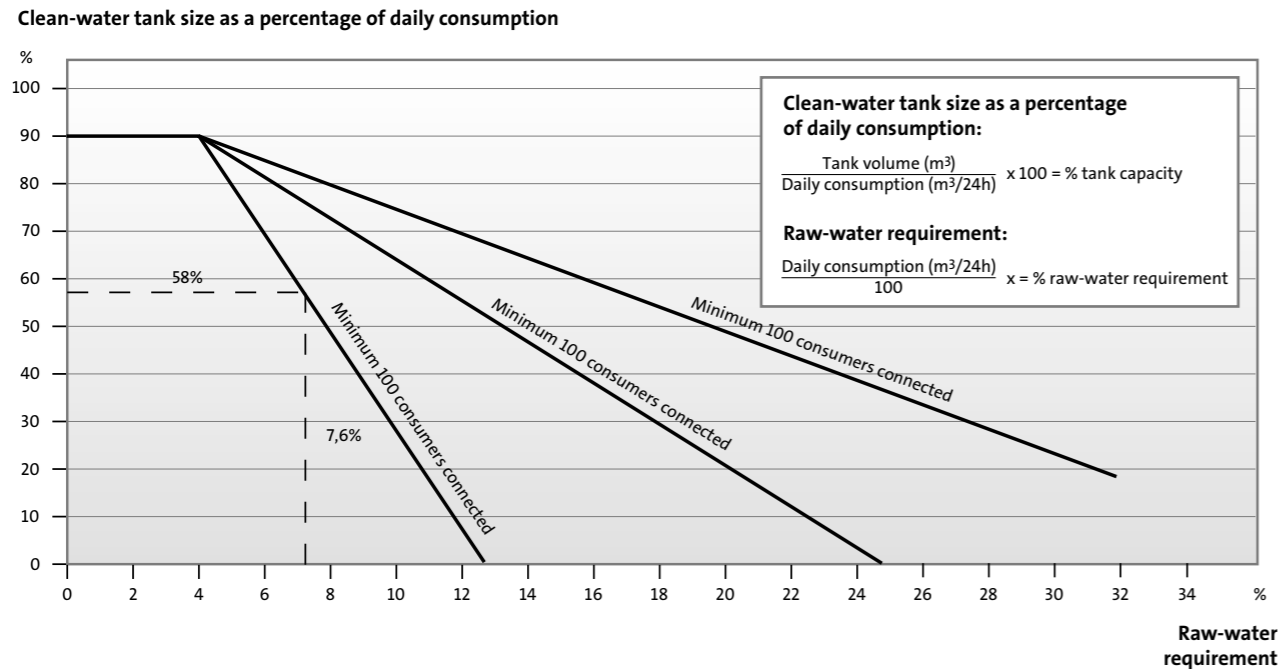

Fig. 6 Raw-water and treatment capacity (m³/h) as a percentage of the daily consumption (m³/day)

2.2.5 Well yield and operational efficiency

Each well has specific capacity, consisting of m³/h for each metre of drawdown of the pumping water level. With your raw-water requirement, you are able to load each well to obtain the lowest average drawdown. The smaller the drawdown, the smaller the total head. The smaller the voltage drop in power cables, the better the operational efficiency.

- Overpumping will result in deep drawdown. This gives room for oxidation, resulting in the formation of ochre which may clog well screen and pump. This means increased service costs for well regeneration and possibly reduced well life.
- Overpumping means lowering of the water level of the aquifer which can result in chemical changes and precipitation of heavy metals. Infiltration of nitrate and pesticides in the water may occur, resulting in increased expenses for water treatment.

The most common cause of overpumping of a well or aquifer is increased water consumption. This is covered by increased pump capacity or longer duty time of the groundwater pumps without increasing the catchment area or the number of wells.

Aquifer load

When pumping at constant capacity for several hours, the dynamic water level in the well should remain fairly constant. If the level is lowered considerably, this means that the amount of pumped water exceeds the influx. If the level drops from year to year, the quantity of pumped water should be reduced and water from other aquifers should be utilised.

Well load

During test pumping, the amount of pumped water is increased at fixed intervals which will result in a lowering of the dynamic water level. If the drawdown is plotted against increased pumping, a rough parabola will result.

Linear drawdown at moderate flows

At moderate flows, this means that typically an increased amount of water of 1 m³/h will result in an almost linear increase in the drawdown of 10 cm/m³.

An increase from 10 to 20 m³/h will consequently result in a lowering of the water level of approx. 1 m. An increase from 10 to 30 m³/h will give a lowering of the water level of approx. 2m.

At moderate flows, the drawdown curve will be close to linear as the increased drawdown is due to flow resistance in screen setting.

Parabolic drawdown at large flows

At increasingly large flows, a progressively increasing frictional resistance in screen setting and aquifer will give a parabolic drawdown curve of the second degree. This means a progressively falling water level in the well with increased pumping.

An increase from 80 to 90 m³/h will give an additional drawdown of approx. 5m; from 80 to 100 m³/h approx. 11 m, i.e. much more than at moderate flows. The most economic well load occurs at a flow where the drawdown curve goes from linear to progressive.

If the well yield is not sufficient to meet the water requirement, even by prolonged operation, the following should be done:

- Have a specialist look at the problem.
- Have a supplementary well drilled.

Please note that rules and regulations may vary from country to country.

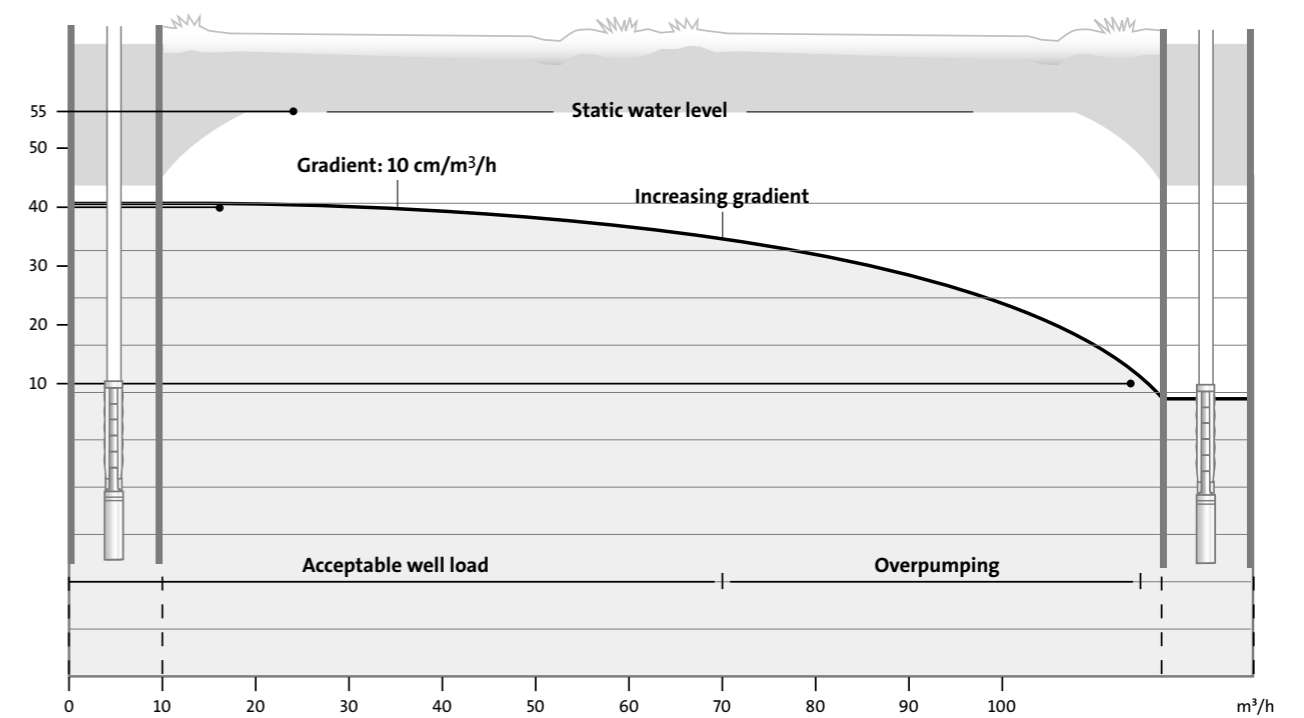

Fig. 7 Dynamic water-level variations by test pumping

2.3 Surface water

2.3.1 From freshwater sources

Surface water is usually taken from lakes or rivers. Unlike groundwater, it is not protected from nature or human activities, and treatment is therefore always necessary. Surface water level and quality will vary over the seasons. For example, after heavy rainfall, or snow melt, lots of solids and sand are washed downstream.

These sharp and abrasive minerals as well as biodegradable materials are to be settled or screened off before pump intake to avoid negative effects on the final water treatment process. Submersible pumps are ideal for these applications with periodic uncontrollably high water levels. Note that power cables and electric equipment must be elevated to permanently dry locations.

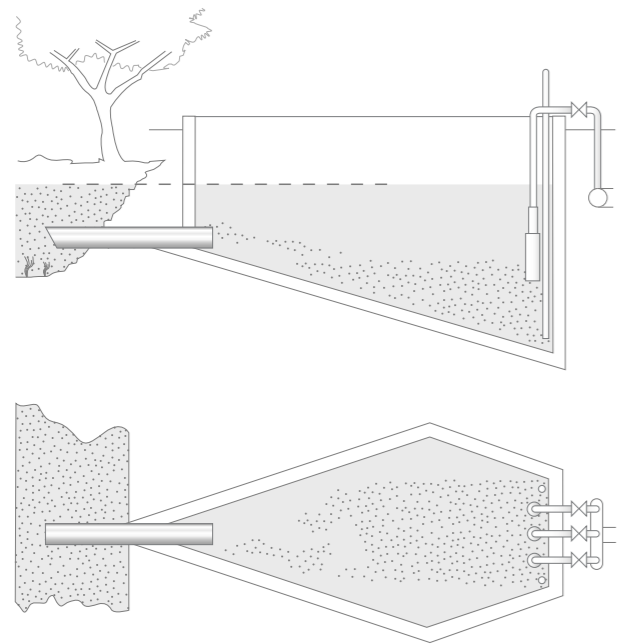

Fig. 8 Settling tank principle

For more permanent installations, indirect riverside infiltration via sand or gravel bank fillings to intake casings or riverbank wells are recommended. This natural filtering improves the water quality and saves up to 20% on power consumption, chemicals and testing at final treatment.

Using direct water intake and standard conventional water treatment will only result in a microscopic diverse biodynamic-balanced fauna entering the accompanying pipework and tank system. The fauna can range from single-celled organisms to millimetre-sized predators. This fauna must be eliminated by dosing high levels of chlorine. Direct water intake at a temperate climate will require chemical overdosing during the coldest season of the year, when chemical reactions have slowed to nearly inactivity.

2.3.2 From sea and saltwater sources

Coastal seawater intake should be placed where the lowest salt content is expected. In the coastal splashing zone, a lot of water evaporates making the salt concentration of remaining waters greater than outside the splashing zone. In fact, it can be up to twice as great.

This makes it necessary to extend the seawater intake up to hundreds of meters from the splashing zone to obtain the lowest salt content. This type of intake structure is generally beneficial when intake capacity exceeds 1,000 m³/h.

For intake capacities lower than 1,000 m³/h, corrosion-safe beach wells and coastal bank filtration wells are recommended. These installations can provide savings of up to 20% per year on costs related to maintenance, repair, power consumption and chemicals at the desalination plant.

Coastal bank filtration wells are constructed like riverbank filtration wells, but in higher corrosion classes to resist the impact from the present salts.

3. Applications



3.1 Freshwater supply

The supply of fresh water for drinking water, irrigation and various industrial applications is the most common application for submersible pumps. Pumps of many different designs, and made from many different materials can be used with a reasonably good result here.

Grundfos SP pumps made of stainless steel EN 1.4301/AISI 304 are the obvious choice for this application. If the well is made correctly and produces clean, sand-free water, the pump can last for many years.

However, in some livestock watering and irrigation applications, the water quality is so poor that pumps made of standard stainless steel material do not survive very long. In these cases a pump in EN 1.4401/AISI 316 or EN 1.4539/AISI 904L stainless steel can be used.

Estimates for a timeframe for carrying out several activities are found in the diagrams below. They include:

- the recommended service periods caused by wear and tear
- the expected service repair cost
- the loss of efficiency in the service periods.

Please note that the diagrams do not reflect loss of efficiency caused by clogging from sediment or scale.

Service intervals for submersible pumps

Submersible pumps are subject to wear just like all other pumps. Unfortunately, their placement underground makes viewing this wear difficult. The diagram here enables you to calculate the following:

- When should I service my submersible pump?
- How much efficiency has been lost since the last service?
- How much will a renovation cost (approximately)?

A number of things must be determined beforehand. They include:

- Water velocity at the component you wish to test
- The conditions related to pump material and the pumping environment
- The presence or absence of solids and aggressive carbon dioxide.

The chart below is useful as a guideline to determine the service intervals for submersible pumps.

Follow the steps below:

1. Note point 1 on Curve A. Pump material and media conditions are as indicated in the legend.
2. Draw a parallel line to the right. Impeller material loss is approx. 0.18mm per 1,000 hours of operation (point 2).
3. Follow the parallel line until you reach the differentiation line that corresponds to aggressive CO2 and component material. Note the conditions in the example (point 3).

4. Drop directly down (90°). The aggressive CO2 content has increased the material loss to 0.25mm. Note the salinity level of the water (point 4). Draw a horizontal line through this point; follow it to the left and read the results.
5. Recommended service intervals for your pump: After every 6,000 hours of operation (point 5).
6. Loss of efficiency: Approx. 18% (point 6).
7. Estimated cost of renovating the pump: 75% of the price of a new pump (point 7).

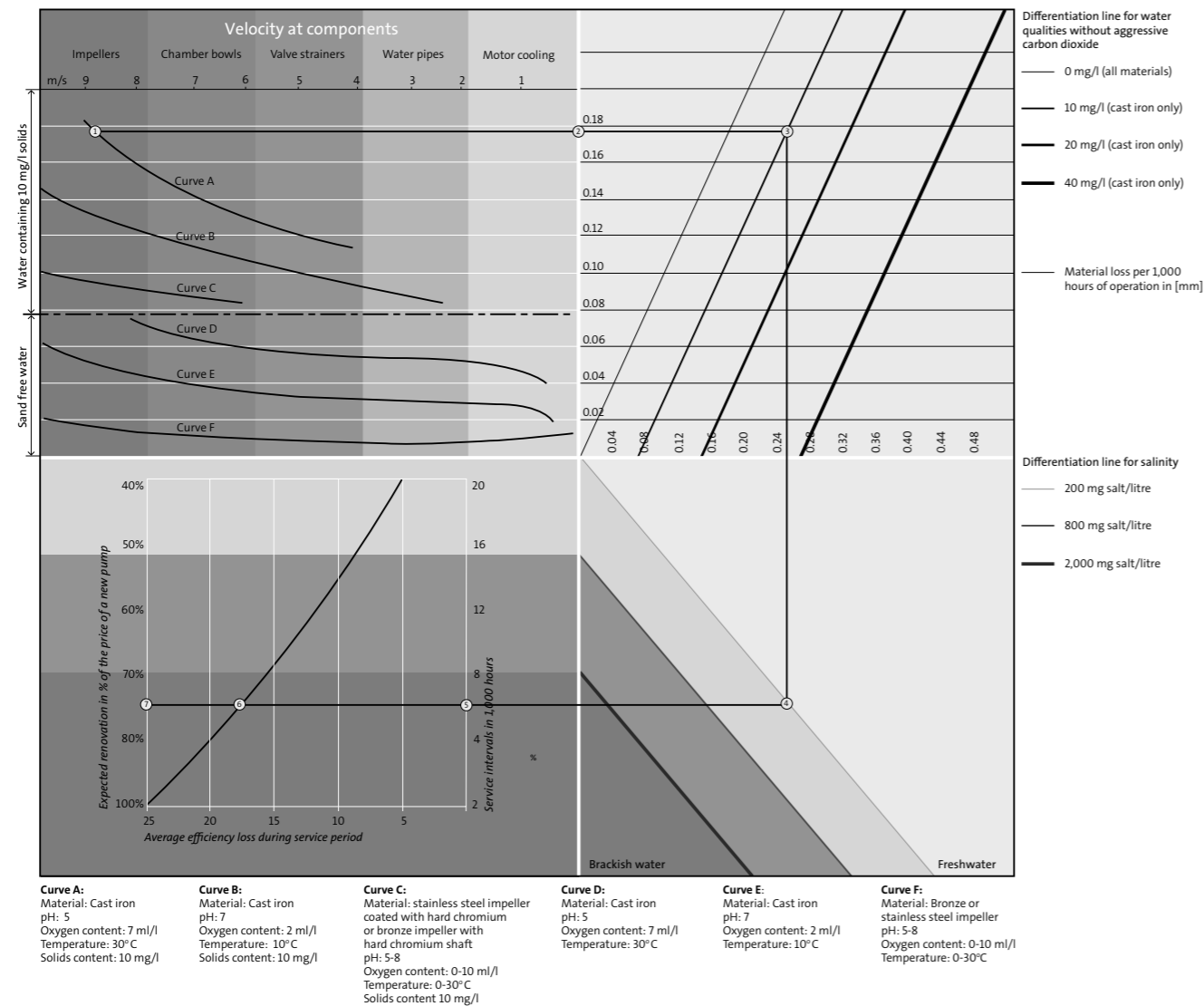

Fig. 9 Recommended service intervals for submersible pumps

3.2 Dewatering

Dewatering in connection with mining applications or construction sites is often done with submersible pumps. The water quality determines whether the pump can be a standard EN 1.4301 (AISI 304) pump, or if it has to be stainless steel of a higher grade.

When reducing groundwater levels, the aquifer is exposed to oxygen, creating rust and other adhesive solids. They are washed out and penetrates the well screen, then passing on to the pump inlet.

To maintain pump performance, the duty point is to be selected to the right of the best efficiency point.

The higher the velocity inside the pump, the longer intervals between service can be. A high velocity prevents the pump from clogging up and losing performance. In very adhesive mixtures, it can be beneficial to remove the non-return valve from the pump to enhance back-wash of the pump and pipes after pump stoppage.

3.2.1 Mining

Mining is a typical dewatering application. However, the water quality is very often aggressive in relation

to the submersible pump, and high-grade stainless steel is recommendable.

A special mining application is leach mining, where an aggressive liquid is used to dissolve the minerals to be mined. These are then pumped with the liquid to the surface and reclaimed.

One way of doing this is described in the following:

1. Find the chloride corrosion potential (chloride equivalent = ppm chloride – (0.5 x ppm acid)).
2. With this chloride equivalent, use fig. 10 to find the minimum pH value acceptable for EN 1.4539 (AISI 904L) stainless steel. If the illustration indicates that there is a high corrosion risk, epoxy-coating of the motor is required.
3. Most power cable materials and junction kits are unstable in acidic waters. If possible, use the blue Grundfos TML motor cable in full length to the junction box on the surface.
4. Install the pump centering device on your pump or motor to ensure perfect cooling of the entire surface.
5. If corrosion occurs, install ion-exchange units to bring down the chloride content, or install zinc anodes as cathodic protection.

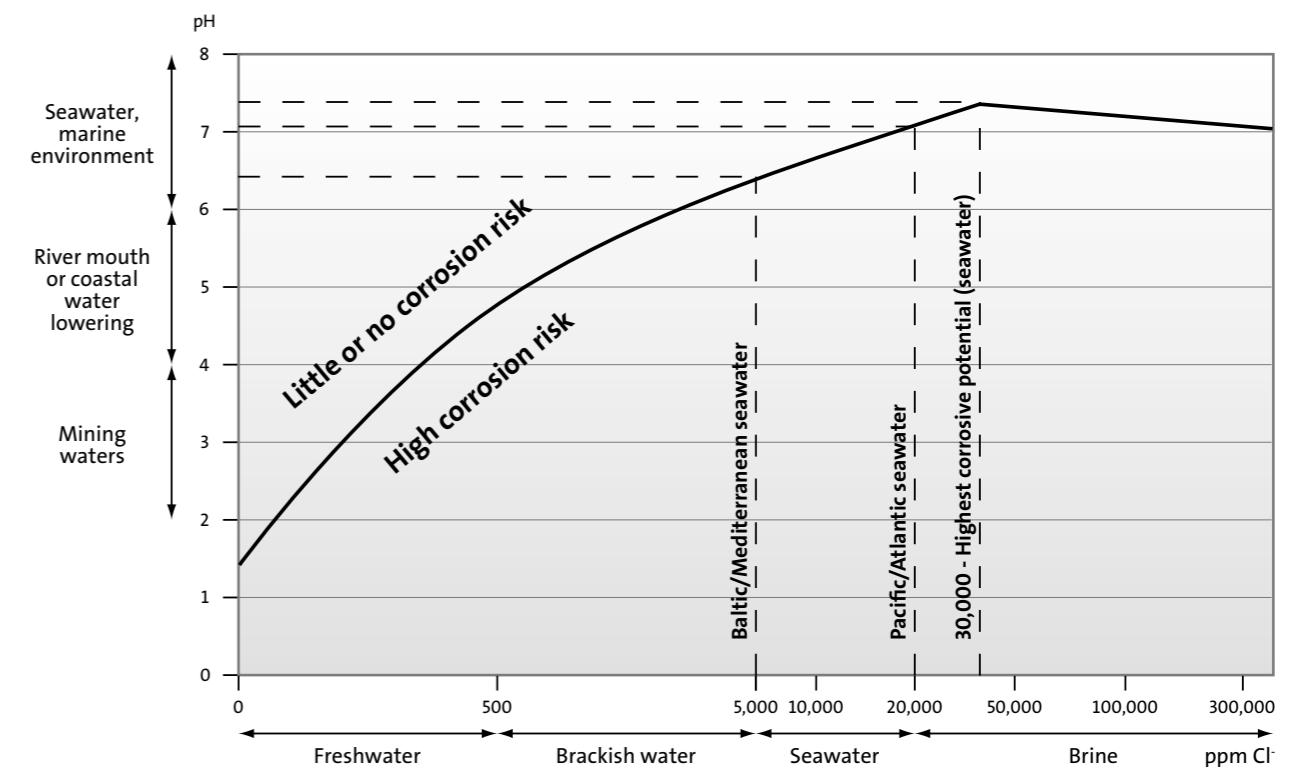

Fig. 10 Corrosion due to chlorides

3.3 Horizontal application

Pumping water from a tank or reservoir is very often done with a standard submersible pump. A submersible pump has many advantages compared to a dry-installed pump such as:

- Low noise level: The submersible pump is very silent and does not disturb any neighbours.
- Theft proof: The pump is installed at the bottom of the tank/reservoir.
- No shaft seal: This eliminates the risk of leakage above ground.

In horizontal installations, Grundfos always recommends that you include a flow sleeve and baffle plate at low water levels.

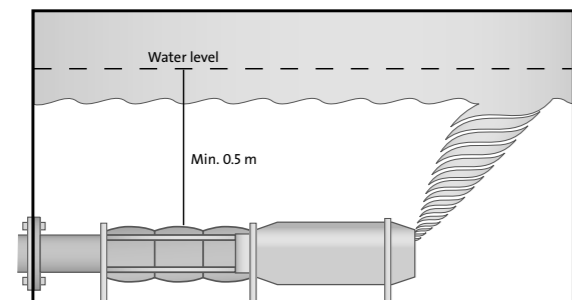

Fig. 11 Flow sleeve on horizontally installed pump

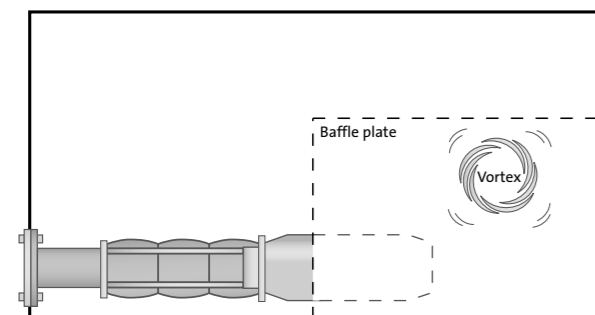

Fig. 12 Vortex baffle plate on horizontally-installed pump (seen from above)

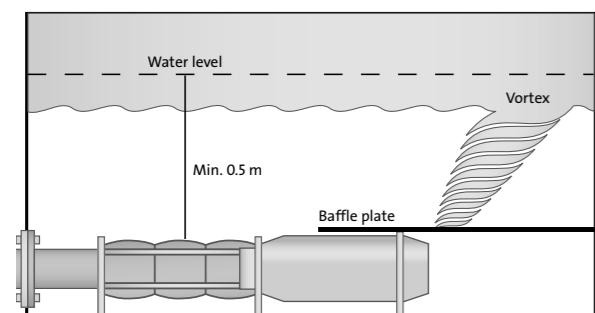

Fig. 13 Vortex baffle plate on horizontally installed pump (cross-section)

If more than one submersible pump is installed in a tank or reservoir the distance between the pumps must equal the overall diameter of the pump and motor including cooling sleeve.

Submersible pumps used for fountain applications are often installed horizontally. Because of its low inertia, a submersible pump is able to start and stop very fast. This makes it ideal for fountain applications. Because of the high start/stop frequency, it is recommended to use canned motors only. Rewindable motors should never be used in connection with an extreme number of starts and stops.

The large number of starts/stops is also hard on the contactors, which have a limited lifetime. In order to protect the motor from failure in the contactors, Grundfos recommends that you install the phase-failure relay between the overload relay and the motor.

Finally, it is important to size the pump and nozzle together, so the pump never operates at maximum flow, but always as close to the best efficiency point as possible.

3.4 Air/gas in water

If air/gas is mixed in the pumped water, the pump will underperform, and sometimes even stop pumping. Air/gas greatly disturbs the hydraulic functions of centrifugal pumps. To improve performance, the pump must be submerged deeper into the well, thus increasing the pressure.

If that is not possible, the problem may be overcome by installing a sleeve around the pump, below the pump inlet. The sleeve should extend upwards as far as possible, but never above the dynamic water level.

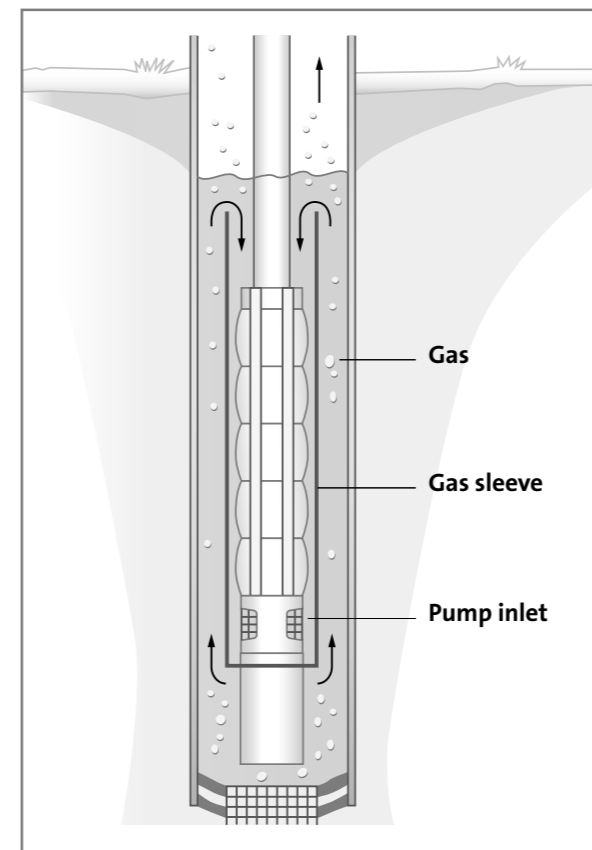

Fig. 14 Gas evacuation

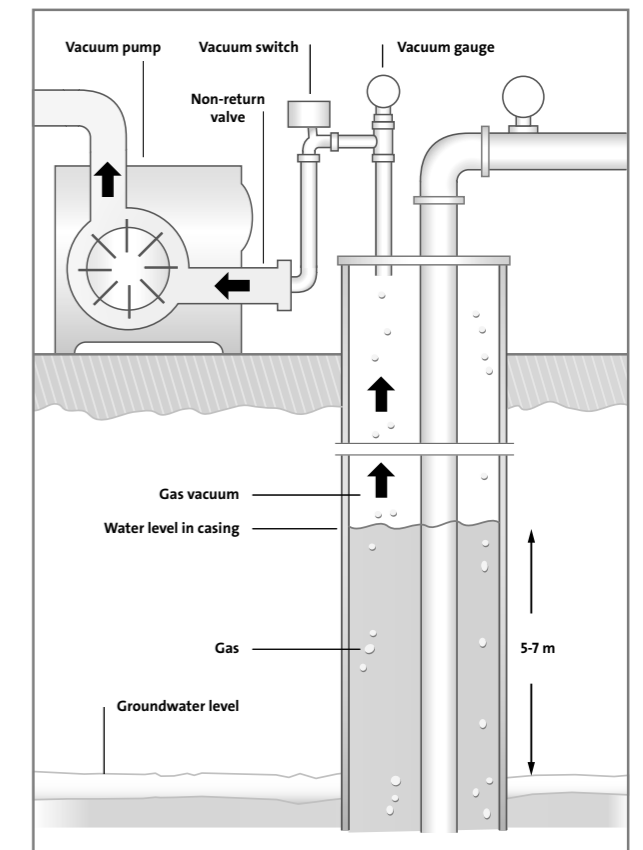

Fig. 15 Vacuum wells

Vacuum wells

If the well water contains so much gas in suspension that a sleeve is insufficient to meet the water quality requirements, a vacuum must be created in the well casing. This can be done by connecting a vacuum

pump to the vent pipe when the casing is hermetically sealed. This requires that the well casing is strong enough to withstand the vacuum and that the NPSH requirement is met.

3.5 Corrosive water (seawater)

Submersible pumps are used for many seawater applications like fish farming, offshore industrial applications and water supply for reverse osmosis-treated water.

SP pumps are available in different materials and corrosion classes depending on the application of the pumps. The combination of salinity and temperature is not favourable to stainless steel, and must always be taken into consideration.

A good way to compare the corrosion resistance of stainless steel, is to compare its resistance against pitting. The figure used as a comparison is called: 'Pitting Resistance Equivalent' (PRE).

Fig. 16 shows the most common stainless steel types used by Grundfos.

$$PRE = (\% Cr) + (3.3 \times \% Mo)$$

For comparison to other stainless steel types, which contain Nitrogen (N) the formula looks like below:

$$PREN = (\% Cr) + (3.3 \times \% Mo) + (16 \times \% N)$$

In addition to temperature and salinity, the corrosion temperature is affected by the presence of other metals, acids and biological activity. This is also indicated in fig. 16.

The chart below can be used for the selection of the proper grade of steel.

Corrosion resistance of seawater-submerged pumps

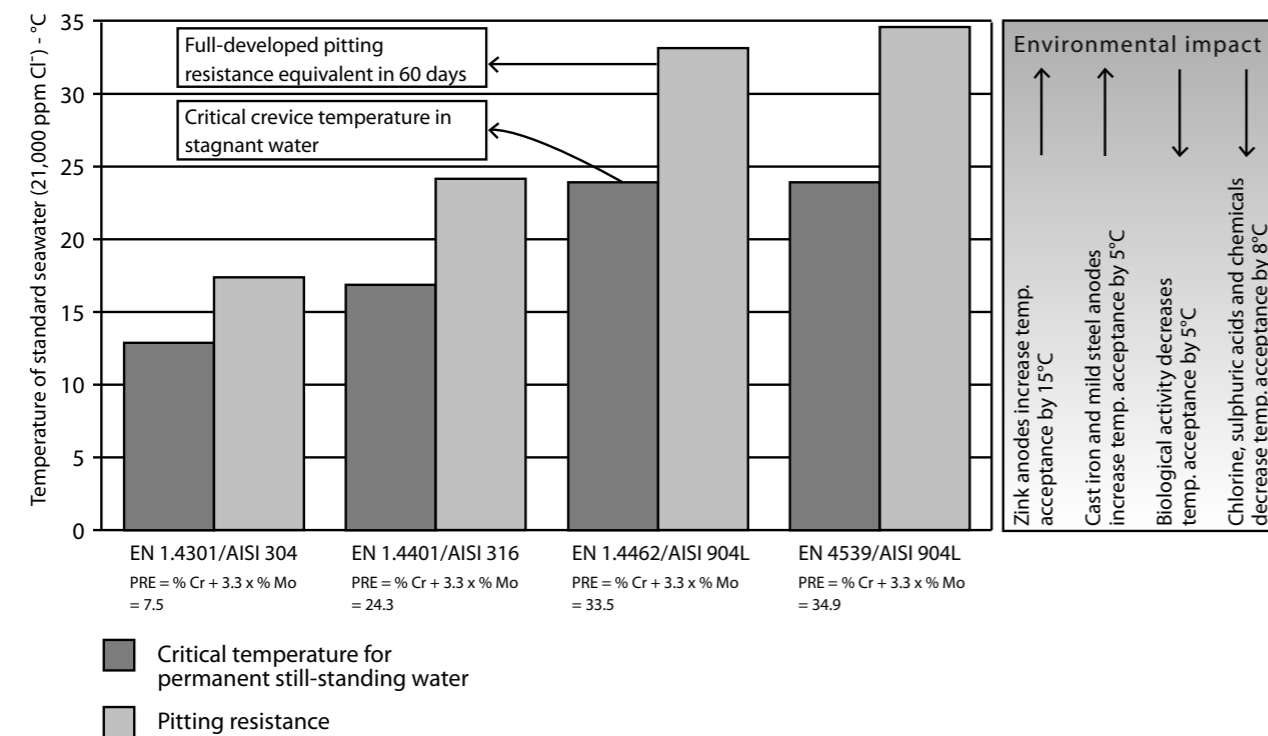

Fig. 16 Corrosion resistance

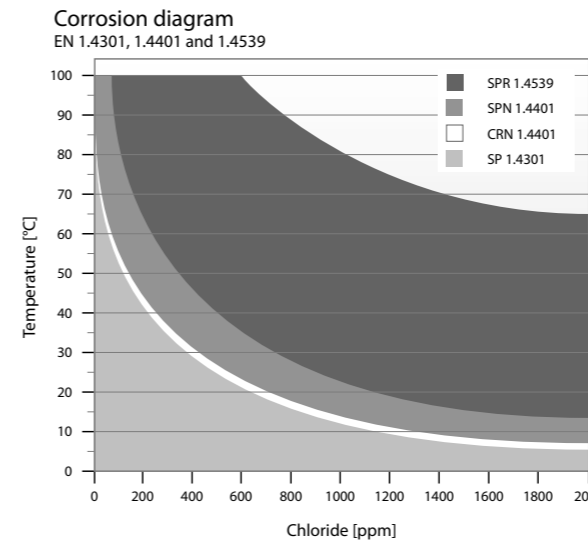

Fig. 17 Corrosion diagram

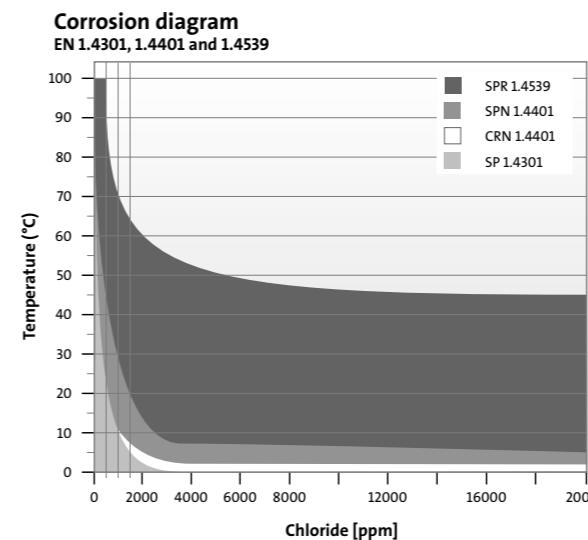

Fig. 18 Corrosion diagram

The elastomer components in the pump may also be damaged by poor water quality, for example if the water has a high content of hydrocarbons and many chemicals. In such cases the standard elastomer can be replaced by FKM rubber. The Grundfos SPE pumps are particularly designed to meet these requirements. For all other models, the pumps can be specified and delivered on request.

3.6 Hot water and geothermal water

Groundwater close to the surface will be close to the average annual air temperature in the region. Going deeper, the temperature will increase 2 to 3 °C for each 100m of well depth, in the absence of geothermal influence.

In geothermal areas, this increase might be as high as 5 to 15 °C for each 100m of well depth. Going deep for water requires temperature-resistant elastomers, electrical cables, connections and motors.

Hot groundwater is used for general heating applications, and for leisure in many areas, especially those with volcanic activity.

The motor liquid of your submersible motor has a higher boiling point temperature than the well water prevents the motor bearing lubrication from being reduced due to the lower viscosity of the liquid. The motor must be submerged deeper to raise the boiling temperature as the table below.

Temperature	Vapour pressure	Kinematic viscosity
°C	mWC	mm ² /s
0	0.00611	1.792
4	0.00813	1.568
10	0.01227	1.307
20	0.02337	1.004
30	0.04241	0.801
40	0.07375	0.658
50	0.12335	0.554
60	0.19920	0.475
70	0.31162	0.413
80	0.47360	0.365
90	0.70109	0.326
100	1.01325	0.294
110	1.43266	0.268
120	1.98543	0.246
130	2.70132	0.228
140	3.61379	0.212
150	4.75997	0.199
160	6.18065	0.188

Gas in the water is to be expected where there is geothermal activity. To avoid reduced pump capacity in a geothermal water installation where air is mixed in, Grundfos recommends to install the pump a minimum of 50m below the dynamic water level.

3.7 Booster modules

Grundfos pump types BM and BME are SP pumps built into a sleeve. By connecting each unit in series, a very high pressure can be obtained.

The pumps are primarily used for reverse osmosis applications, producing clean water from polluted water or seawater.

Grundfos booster modules are also used for water supply in distribution networks to boost water pressure over long distribution lines. The main advantages compared to conventional booster pumps are the quiet operation, and there is no shaft seal that may leak.



Fig. 19 Grundfos BM

4.1 Pump principle

The SP pump is a centrifugal pump, where the pump principle is to transform mechanical energy from the motor to velocity energy in the pumped medium, and thereby creating a pressure difference in the media between the pump inlet and outlet.

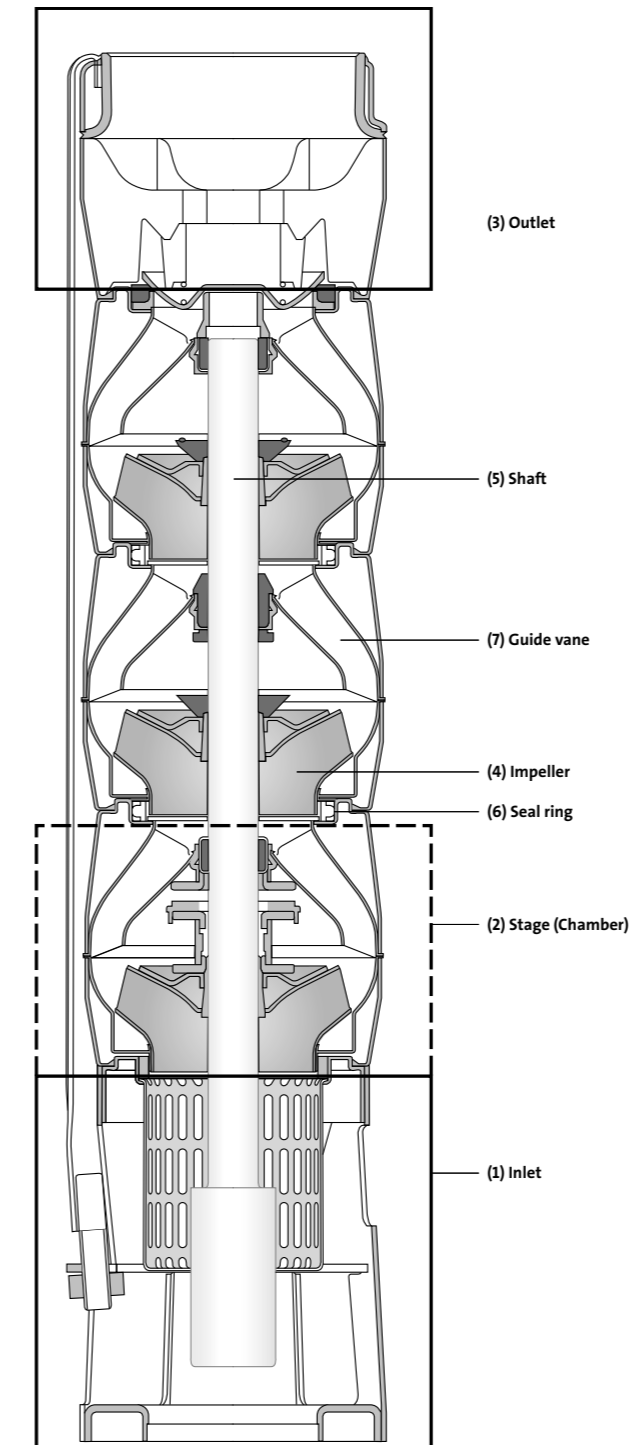

Fig. 20 Submersible pump principle

The pump consists in principle of an inlet (1), a number of pump stages (2) and a pump outlet (3). Each pump stage creates a pressure difference, and the more pressure needed, the more stages need to be included.

A pump stage includes an impeller (4) where the impeller blades transfer energy to the water in terms of a velocity and pressure increase. Each impeller is fixed to the pump shaft (5) by means of a spline connection or split-cone connection.

For submersible pumps, there are two general design types:

- radial
- semi-axial.

The radial design is characterised by a large difference between the impeller inlet and the outlet diameter of the impeller. It is suitable where a high head is required.

The semi-axial design is more suitable for larger flow pumps.

A seal ring (6) between the impeller inlet and the chamber ensures that any back flow is limited. The chamber includes a guide vane (7), which leads the water to the next stage. It also converts the dynamic pressure into static pressure.

In addition to guiding the water into the first impellers, the pump inlet is also the interconnector for the motor. For most pumps the dimensions conform to the NEMA standard for 4", 6" and 8". For larger pumps and motors there are various standards depending on the supplier. The pump inlet must be designed in order to deliver the water to the first impeller in the best possible way and thereby minimise the losses as much as possible. For some radial designed impellers, the inlet also includes a priming screw (fastened on the pump shaft) in order to secure the water intake and avoid dry running of the pump.

The pump outlet normally includes a non-return valve, which prevents back flow in the riser pipe,

when the pump is stopped. Several benefits are obtained such as:

- Energy loss due to back flush is avoided.
- A counter pressure is always ensured, when starting up the pump again. This is essential in order to make certain that pump performance remains on the pump curve.
- Damage in the pump due to water hammering is limited.
- Contamination of the groundwater due to back flush is limited.

4.2 Wear parts

Depending on the pumped media and the number of years a pump has been in operation, a service inspection of the pump is recommended. This includes replacing all wear parts in the pump. The recommended service parts are:

- bearings, radial
- valve seat
- neck rings
- seal ring
- upthrust ring.

If extensive wear from sand has occurred in the pump, replacing the pump shaft and impellers may also be necessary.

Renewing the wear parts in case of service is essential for maintaining a high pump efficiency and a low operating cost.

For further service information, see the Grundfos service instructions.

4.3 Pump selection

Selection of a pump starts with estimating the flow and pressure. The total head is the sum of the following

- dynamic water table (1)
- lift above ground (2)
- discharge pressure (3)
- losses in pipes, valve and bends (4)

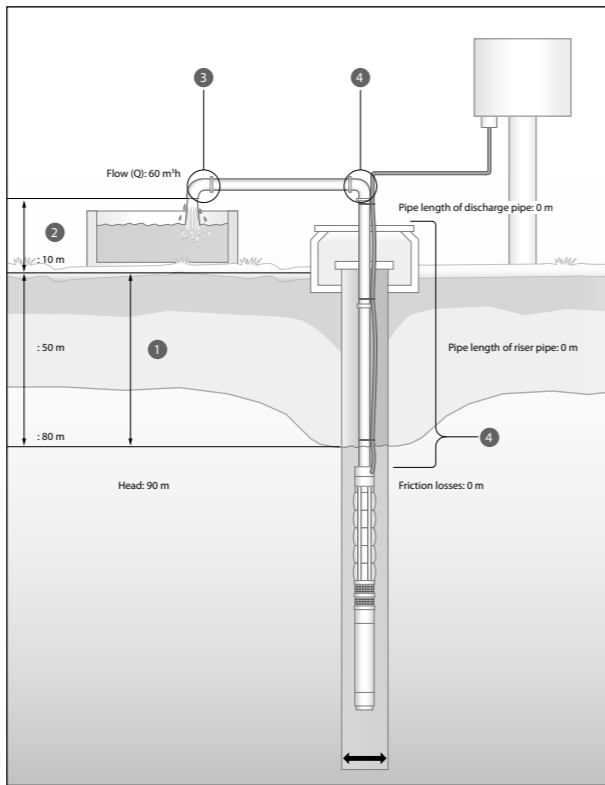

Fig. 21 Total head calculation

When estimating the flow demand, the well yield must also be taken into consideration. Information regarding the well yield is available from the well drillers test report, which is made during well development. If possible, the necessary flow must be reduced as much as possible. This will minimise the water table drawdown, and reduce total power consumption in terms of kWh/m³.

4.4 Pump curves and tolerances

After estimating the necessary flow and head, pump selection can be performed by using Grundfos WinCAPS/WebCAPS or the corresponding pump data booklet. Both sources contain performance curves.

In addition to the pump head, the required power consumption is also available in the data booklet, where the pump supplier distinguishes between the motor shaft power output P1 (printed on the motor nameplate) and the motor input power, P1. P1 is used for sizing the electrical installations.

Please note that P4 is the hydraulic effect produced by the pump.

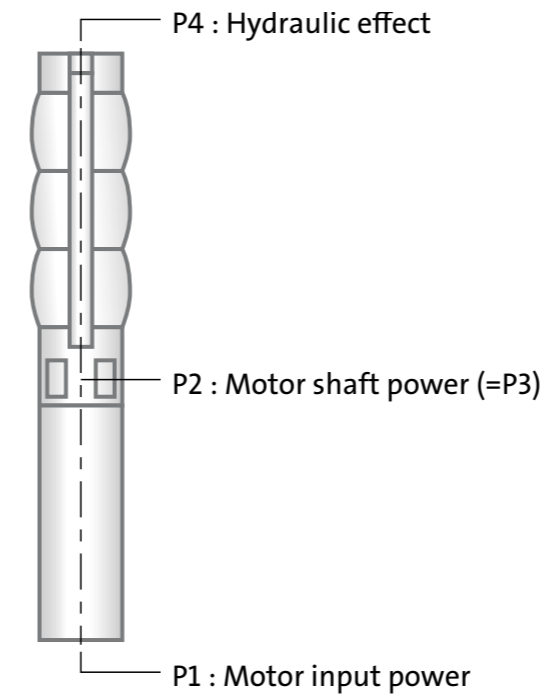

Fig. 22 Power definitions

Normally the power consumption is also shown as a function of the flow.

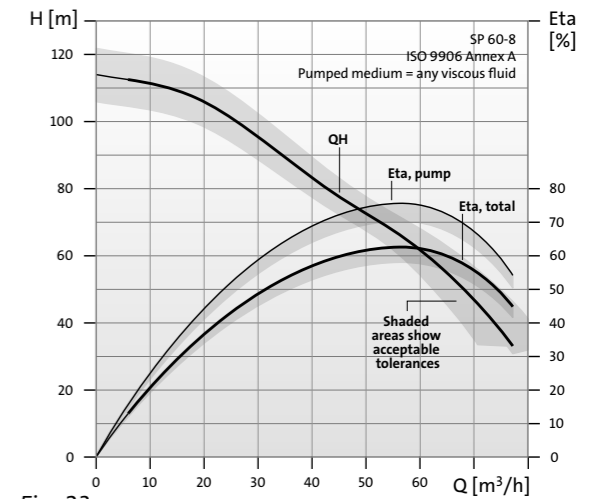

Fig. 23

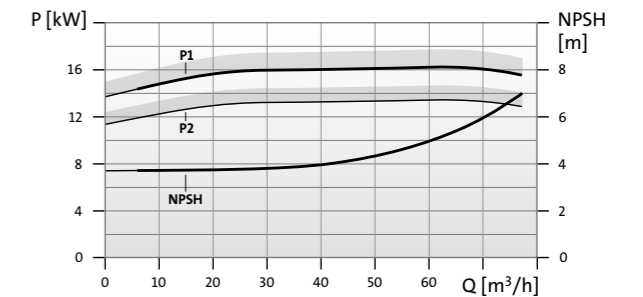

Fig. 24

Figures 23 and 24 Pump performance parameters including tolerances

In the data booklet, information regarding pump efficiency is also available, and it can be shown as the pump-end efficiency (based on P2) or as a complete pump efficiency including the motor (based on P1). In some cases, losses in non-return valves are not included in the efficiency shown. The efficiency curves are used for the selection of pump size, where the best efficiency area matches the required flow. If the complete pump efficiency is not shown, it can be calculated by using the flow (Q), head (H) and power input P1:

$$\eta_{total} = (Q \times H \times 9.81) / (P1 \times 3600)$$

The NPSH value stands for “Net Positive Suction Head” and is a measure for required inlet pressure = minimum water level above pump inlet.

In general, the NPSH value will increase for bigger

flows and if the required inlet pressure is not met, it will result in evaporation of the water and a risk of cavitation damage in the pump.

In general, there are many different local standards for tolerances on performance curves. Pump performance for Grundfos SP pumps is shown according to ISO 9906, Annex A. QH curves printed in the documentation show the nominal curve. According to ISO 9906, Annex A, power curves only have an upper tolerance. For efficiency curves, only lower tolerances are shown. Please see the example shown in fig. 23 and 24 above. The general conditions according to ISO 9906 for the performance curves in this illustration are:

- The measurements are made with airless water at a temperature of 20 °C.
- Curves apply to a kinematic viscosity of 1 mm²/s. When pumping liquids with a higher density, a higher motor output is required.

In addition to QH, Q-P, Q-eta curves, an axial load curve is normally also available on request. The down thrust load is created by the hydraulics and transferred to the motor thrust bearing. The total axial load is calculated by multiplying the single-stage values by the number of stages. It can be used to check whether the capacity of the motor thrust bearing is sufficient.

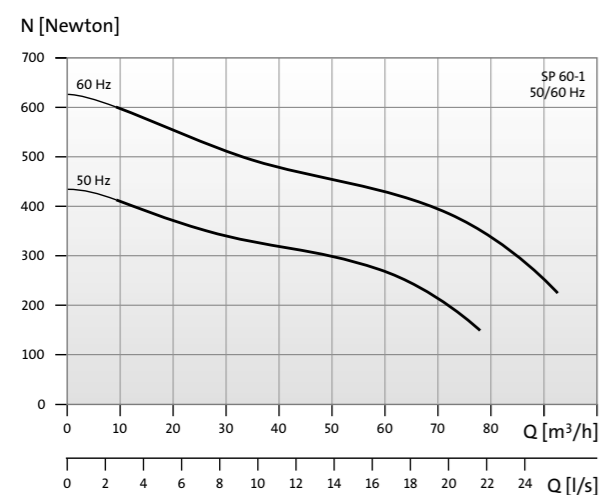
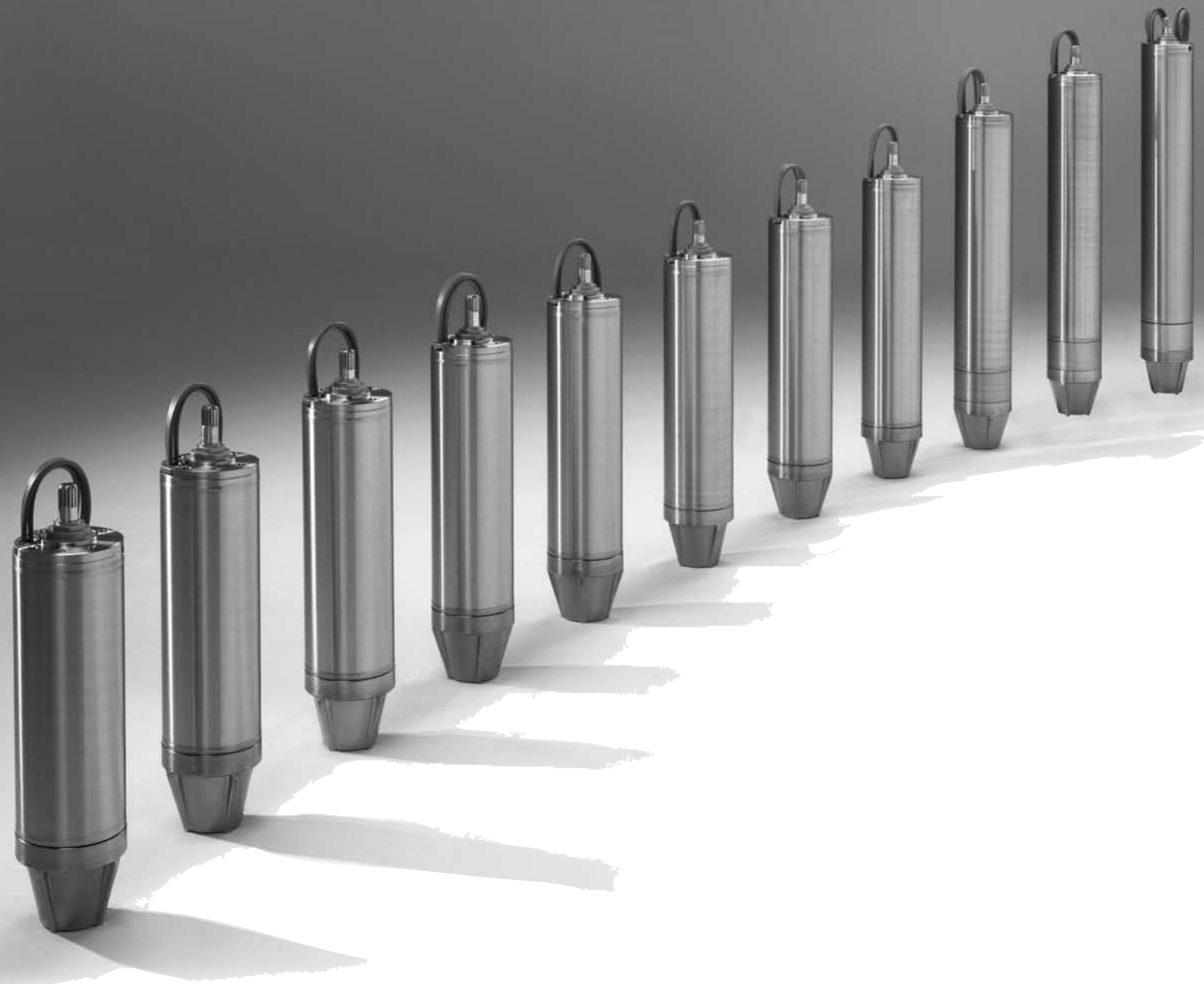

Fig. 25 Single-stage axial-load curve, SP 60



5.1 Motor types, general description

This chapter deals exclusively with submersible motors, and controls for submersible motors. Submersible motors are special because they are designed to run underwater. Otherwise, their operating principle is the same as all other electric motors.

Please note that all Grundfos 4", 6", and 8" motors conform to NEMA standards.

A submersible motor consists of a motor body and a motor cable. The cable is detachable in a plug system. The cable is dimensioned for submerged use in order to minimise the spatial requirement along the pump. The motor cable is connected to the drop cable above the pump by use of a cable termination kit. The drop cable used to raise and lower the pump.

Canned

In a canned motor, the windings are enamel wire (like in standard surface motors) hermetically sealed from the surroundings and filled with embedding material in order to withhold the windings and at the same time increase heat transfer. These motors have a journal bearing system, consisting of upper and lower radial bearings as well as upthrust and downthrust bearings. Thrust and journal bearings run hydrodynamically in the water-based motor liquid.

Wetwound (rewindable)

Wetwound motors have a special water resistance wire, and a watertight joint between the windings and the motor cable. The joint is always inside the motor, and no plug system is available.

The motor liquid mainly consists of clean water. The liquid circulates around the entire motor, transferring heat away from windings and rotor and lubricating the bearing systems.

Oil-filled

An oil-filled motor is equipped with an impregnated standard surface motor winding. Transformer oil is filled into the motor and used as lubricant and cooling. The oil can be mineral or vegetable oil with high insulation resistance. The motor cable splice is typically made inside the motor as in a wetwound mo-

tors, few have plug systems. Oil-filled motors incorporate a ball-bearing system.

Single-phase motors

There are several versions of single phase motors. They all have their distinctive advantages and disadvantages. Most types need a capacitor and some other accessories, which is built into a starter box. The starter box is dedicated for starting a given motor at specific voltage and frequency.

Permanent-split capacitor (PSC) motors

Simple and reliable, PSC motors have a run-type capacitor included in the circuit. The capacitor size is a compromise between adding starting torque and ensuring a high efficiency during operation.

Pros: Simple, low-cost, reliable and silent.

Cons: Low locked-rotor torque and low efficiency.

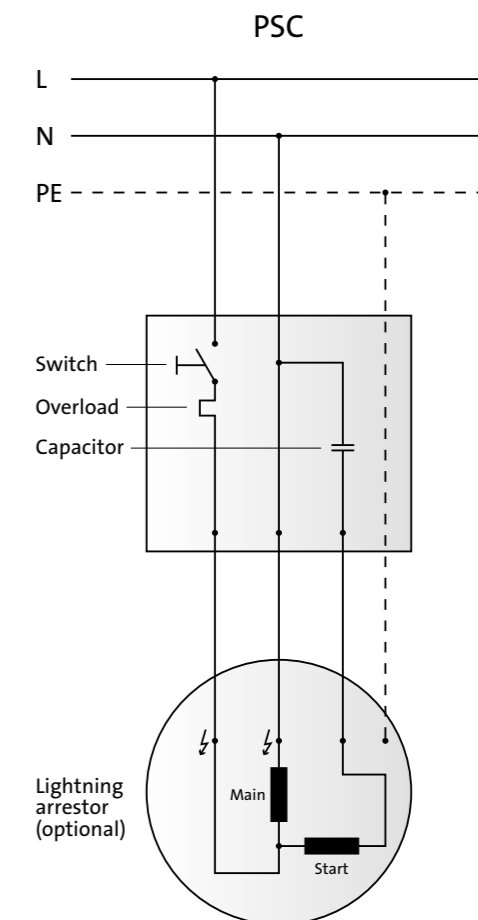

Fig. 26 PSC

Capacitor-start/induction-run (CSIR) motor

The start-up capacitor boosts the torque during start up. Then it is disconnected by a switch. The CSIR motor type is typically used for smaller kW ratings.

Pros: Locked-rotor torque.

Cons: Noisy operation (true single-phase), relay needed to cut out the start-up capacitor.

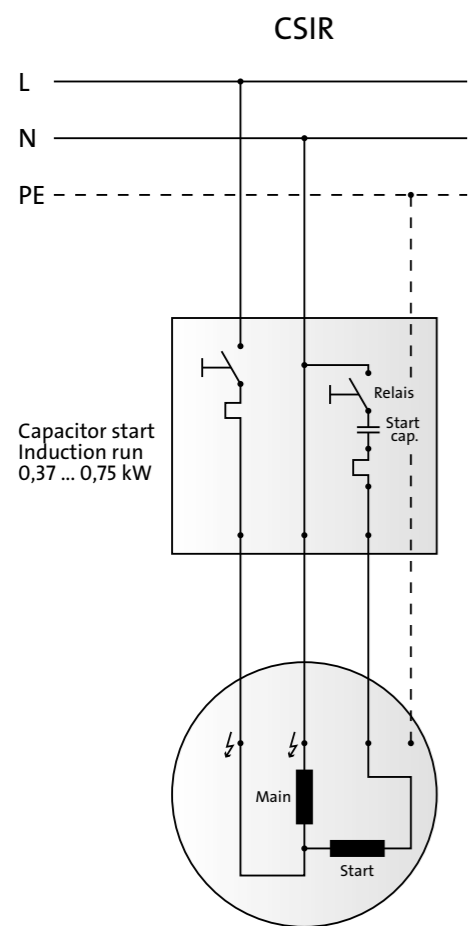

Fig. 27 Schematic diagram of a CSIR motor

Capacitor-start/capacitor-run (CSCR) motors

This motor type has both a starting capacitor to boost starting torque, and a run capacitor (PSC). This ensures a smooth operation and a good efficiency. The motor type combines the advantages of both of the above types.

Pros: Good starting torque, high efficiency.

Cons: Price of control box.

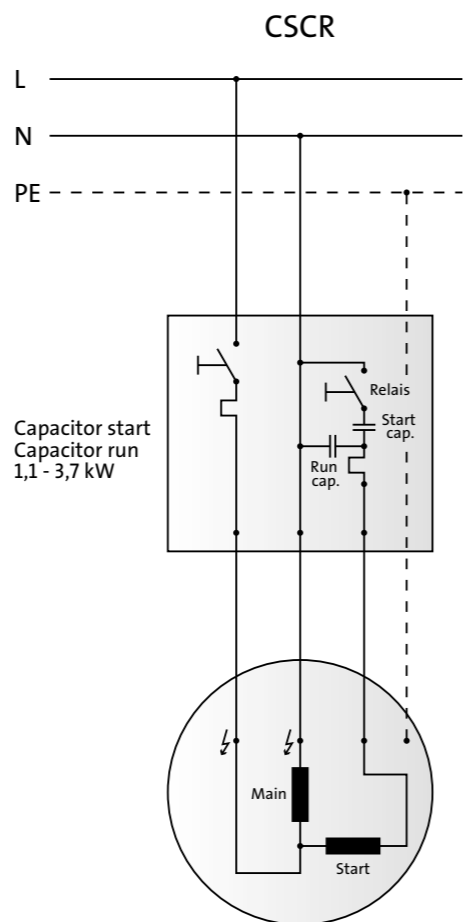

Fig. 28 Schematic diagram of a CSCR motor

Resistance-start/induction-run (RSIR) motor

This motor has a relay built directly into the motor winding. The relay disconnects the starting phase when the motor is running.

Pros: No need for capacitors (no control box), ease of installation.

Cons: Limited starting torque, limited kW ratings (only through 1.1 kW).

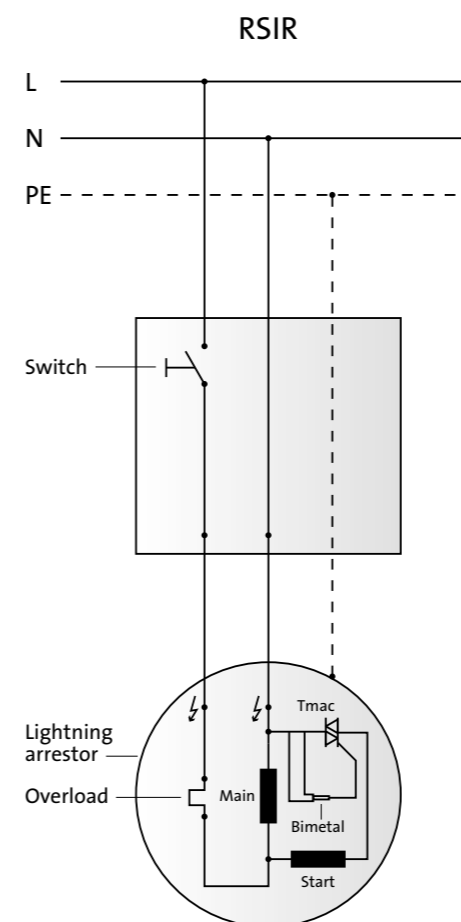

Fig. 29 RSIR motor

Terminology; 2-wire and 3-wire motors

The terminology is related to the number of wires needed in the installation excluding earth cable. 2-wire motors must be supplied by three leads : phase, neutral and earth. 3-wire motors must be supplied by four leads: phase, neutral, point between start- and run- winding in motor + earth cable.

2-wire motors:

- PSC motors a capacitor is built into the motor.
- RSIR.

3-wire motors:

- PSC motors if there is a capacitor in the starter box on the ground.
- CSIR motors
- CSCR motors

Motor derating

Motor derating is where there are special requirements to the motor, such as high water temperature, voltage tolerances outside of acceptable interval, or voltage unbalance. All of these situations stress the motor winding more than what it has been designed for.

The simplest solution is to use an oversized motor, typically not more two output sizes above the required output. The result is an extended lifetime, but the efficiency is not optimal, since the motor never operates at its optimal duty point. The power factor is normally be low due to the partial load on the construction.

A better solution is to have a motor specially wound in a larger stack length. Due to the increased surface, the electrical data and cooling capability are improved. These motors are designed for higher temperatures, wider voltage tolerances, etc. Also, the efficiency of a standard motor is maintained or even increased.

5.2 Motor cables and joints, reference to drop cables

Submersible pump installation are designed to be used with the submersible motor, the motor cable and the joint between motor cable and drop cable underwater. If for any reason the motor cable is not fully submerged, the current-carrying capacity must always be checked. See chapter 7.5 as well.

Therefore, the motor cable, joint and submerged part of the drop cable have a relative large surface area that is in contact with the pumped media. It is important to choose the correct material for the given installation. You must also be aware of your local drinking water approval requirements.

5.3 Motor protection devices

The same type of motor-protective devices used for standard surface motors can be used for submersible motors. It is important to secure and limit short-circuiting currents and protect against phase-failures as well as overload.

Most single-phase motors have a built-in thermal protector. If the protector is not built into the winding, it must be incorporated in the starter box. The protectors feature automatic or manual reset. Thermal protectors are designed to match the motor winding characteristics.

Pt100 and Pt1000 are linear resistors. Combined with a standard sensor device, they can indicate the temperature development over time. On canned-type motors, the sensor device is placed in the staybolt hole; on wet-wound versions, the sensor device is placed in the motor liquid.

PTC and NTC resistors are rarely used in submersible installations because they are not sufficiently fast and reliable to protect the submersible motor.

Grundfos offers a special temperature sensing device called Tempcon. It is a NTC-resistor built in near the winding, and senses the temperature. The temperature is converted into a high-frequency signal, transmitted to the control panel by means of power-line communication. From the control panel, the signal can be picked up by a signal converter, transmitted to the MP 204 control panel and indicated as a temperature on the MP 204 control panel display. MP 204 is an advanced motor protector designed for the protection of the submersible motor against net disturbances.

5.4 Reducing the locked-rotor current

The purpose of reducing the locked-rotor current is to protect other equipment against power surges in connection with high power loads. This also protects the piping against excessive pressure surges. There

are several ways of reducing the impact on the mains, however not all of them are relevant to pumps. This section covers several different ways of reducing the locked-rotor current, and information about running submersible pumps with frequency converters.

The following applies to radial and semi-radial pumps, including Grundfos SP pumps. Axial pumps are however not dealt with here.

As the locked-rotor current of a pump motor is often 4-7 times as high as the rated current, there will be a considerable peak load of grid and motor for a short period. In order to protect the grid, many countries have regulations for reducing the locked-rotor current. Normally it is given as a maximum load in kW or in Amps allowed to start Direct on Line (DOL); The maximum load allowed varies quite a lot throughout the world, so you must be certain that you adhere to your local regulations. In some cases, only specific methods for reducing the locked-rotor current are allowed.

The following types are described in the following:

- DOL - Direct-on-line
- SD- Star-delta
- AF - Autotransformer
- RR – Resistor starter
- SS - Soft starter
- FC - Frequency converter

Before a choice is made, application, requirements and local standards must be considered.

5.4.1 Direct-on-line – DOL

In DOL starting, the motor is coupled directly to the grid by means of a contactor or similar. Assuming all other aspects to be the same, DOL starting will always give the lowest generation of heat in the motor, consequently providing the longest life span of motors up to 45 kW. Above this size, the mechanical impact on the motor will be so considerable that Grundfos recommends current reduction. Furthermore, although

Type	Reduced locked-rotor current	Price	Features in relation to price	Space requirement	Customer friendly	Reliable	Reduced pressure surge		Energy savings during operation
							Mechanical	Hydraulic	
DOL	No	Low	OK	Low	Yes	Yes	No	No	No
SD Below 45 kW above 45 kW	No Yes	Low Low	Low OK	Low Low	Yes Yes	Yes Yes	No	No No	No No
AF	Yes	Medium	OK	Medium	Yes/No	Yes	Yes/No	No	No
RR									
SS	Yes	Medium	OK	Medium	Yes/No	Yes/No	Yes	No	Yes/No
FC	Yes	High	OK	Medium/high	Yes/No	Yes/No	Yes	Yes/No	Yes/No

the DOL motor starter gives the highest locked-rotor current, it will cause minimal grid disturbance.

Lots of submersible pumps use long cables, however. These long cables automatically trigger a reduction of the locked-rotor current due to the simple physics involved, as the resistance in the cable reduces the current. If, for example, the cable is long and designed for a voltage drop of 5 % full load (amps), a reduction of the locked-rotor current will occur automatically. The example below illustrates this point.

Example:
x operating current

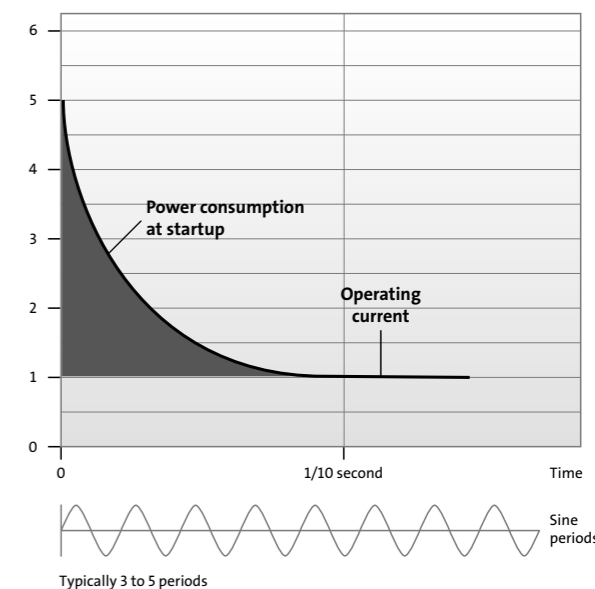

Fig. 30 Current flow by DOL starting

5.4.2 Star-delta – SD

The most common method for reducing the locked-rotor current for motors in general is star-delta starting. During start-up, the motor is connected for star operation. When the motor is running, it is switched over to delta connection. This happens automatically after a fixed period of time. During start-up in star position, the voltage on motor terminals is reduced to 58 % of the nominal starting voltage. This starting method is very well known in the market and relatively cheap, simple and reliable, which makes it very popular.

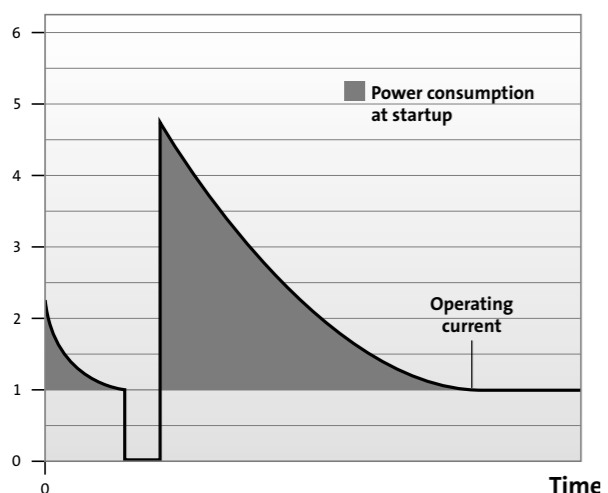

Fig. 31 Current flow by SD starting

For SP pumps, and in general for pumps with a low moment of inertia, SD starting is not recommended due to the fact that speed is lost during switching from Y/D. A submersible pump goes from 0 to 2.900 rpm within three cycles (0.06 s)! This also means that the pump stops immediately when the current is disconnected from the mains.

When comparing the DOL and star-delta locked-rotor current, star-delta starting reduces the current at the beginning. When switching over from star to delta, the pump slows considerably, almost stopping completely. Afterwards, it has to start directly in delta (DOL). The diagram shows that there is no real reduction of the locked-rotor current.

Things are somewhat different for centrifugal pumps with a greater diameter and mass, as they consequently have a higher moment of inertia. Remember that star operation for too long may result in considerable motor heating and a reduced life time as a result.

Submersible installations with SD starters will often be more expensive than other similar installations. Two supply cables (6 leads) are required for the motor instead of one (3 leads) in the normal situation. The motor must also feature two sockets, making it typically 5% more expensive than a traditional, single-socket motor.

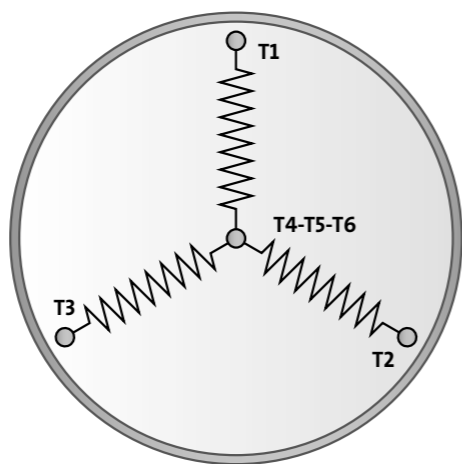

Fig. 32. Wye eonfiguration at start-up

After a pre-determined time, the starter electrically switches the windings over to the Delta Configuration, shown in fig. 33.

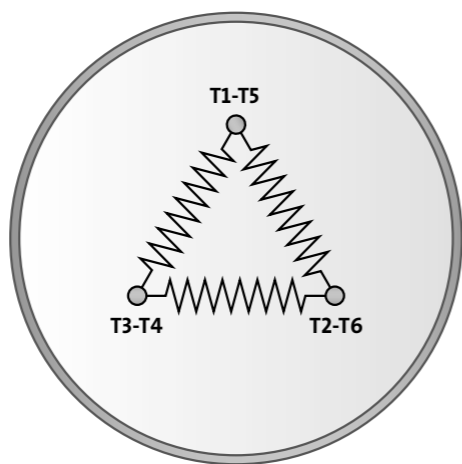

Fig. 33. Delta Configuration motor

5.4.3 Autotransformer – AT

In this starting method, the voltage is reduced by means of autotransformers. This principle is also called the Korndorf method.

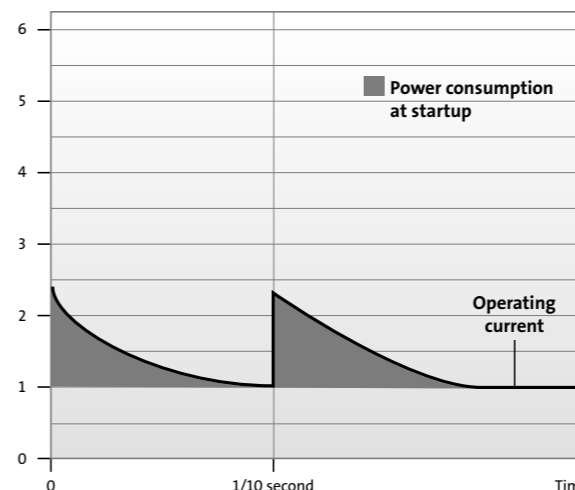

Fig. 34 Current flow by autotransformer starting

When the motor is to be started, it is first connected to a reduced voltage, with full voltage following afterwards. During this switchover, part of the autotransformer is connected as a choke coil. This means that the motor will be connected to the grid the entire time. Motor speed will not be reduced. The power consumption when starting can be seen from fig. 34.

Autotransformer starters are relatively expensive, but very reliable. The locked-rotor current naturally depends on the characteristics of motor and pump, and varies considerably from type to type.

Never have the autotransformer in the circuit for more than 3 seconds.

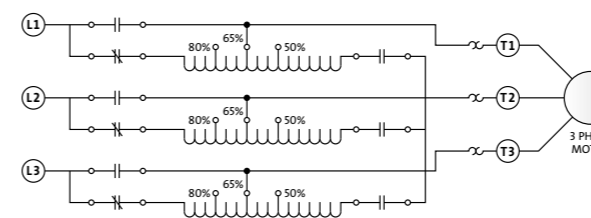

Fig. 35 Typical electrical diagram for an autotransformer reduced voltage starter

5.4.4 Primary resistor-type starter, RR

In this starting method, the voltage is reduced by means of resistors put in series on each motor phase. The function is to increase the resistance during the start thus limiting the locked-rotor current flowing. A correctly dimensioned starter will reduce the starting voltage (on the terminals of the motor) to approximately 70% of the line voltage.

The starter is cut out by means of a timer controlling a contactor which means that the reduced voltage will only be present for the predefined time and that the motor is energized the entire time.

Never have resistors connected for more than 3 seconds, as it will reduce the starting torque with consequently increased winding.

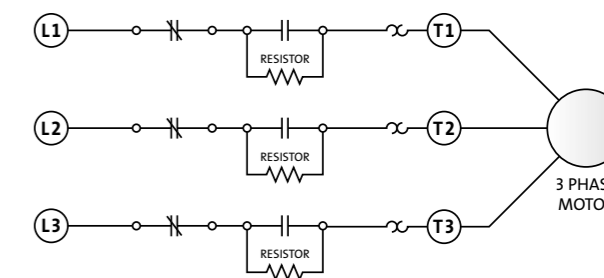

Fig. 36. Typical electrical diagram for a primary resistor reduced voltage starter

5.4.5 Soft starter – SS

A soft starter is an electronic unit which reduces the voltage and consequently the locked-rotor current by means of phase-angle control. The electronics unit consists of a control section, where the different operating and protective parameters are set, and a power part with triacs.

The locked-rotor current is typically reduced to 2-3 times the operating current.

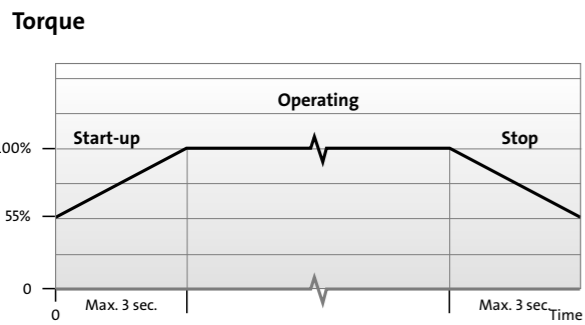

Fig. 37 Recommended start-up and stop time, max. 3 sec.

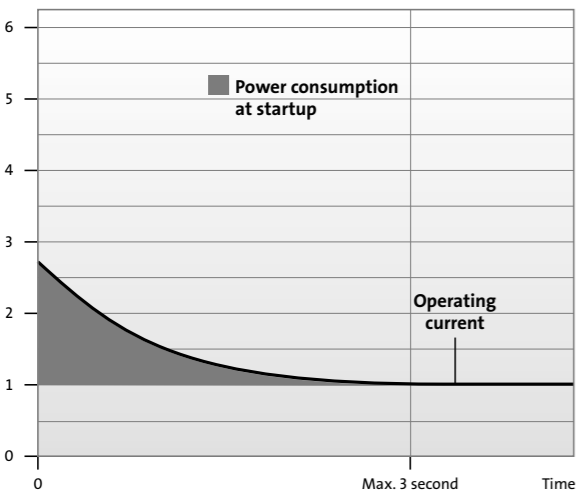

Fig. 38 Current flow by soft starting

Other things being the same, this also gives a reduced starting torque. The slow start may result in an increased heat generation in the motor, leading to a reduced lifetime. With short acceleration/deceleration times (such as three seconds), this is of no practical importance. The same goes for SD and AT starting.

Grundfos therefore recommends following the acceleration/deceleration times stated in the figure when using a soft starter. It should not be necessary in connection with Grundfos pumps to raise the starting voltage above 55%. However if a particularly high starting torque is required, the starting voltage may be increased to achieve the required torque.

A soft starter will absorb a non-sinusoidal current and give rise to some grid noise. In connection with very short acceleration/deceleration times, this is of no practical importance and does not conflict with regulations concerning grid noise.

A new series/generation of soft starters has been introduced. They are equipped with a programmable start ramp function for reducing the locked-rotor current further, or for ramping high inertia loads. If such soft starters are used, please use ramp times of max. three seconds. In general, Grundfos recommends that you always install the soft starter with a bypass contactor, enabling the motor to run DOL during operation. In this way, wear and power loss is avoided in the soft starter during operation.

Please note that if ramping down is required, it might not be possible to use the bypass contactor solution for reducing the power consumption during normal operation.

We recommend the use of frequency converters if other ramp times are required.

Temperature readout of Grundfos motors with temperature transmitters is possible if the soft starter has a bypass contactor.

Soft starters may only be used on 3 phase submersible motors. Max. time for reduced voltage shall be limited not to exceed 3 seconds.

5.4.6 Frequency converters (variable speed drive)

Frequency converters are the ideal device to control the performance of the pump, by adjusting the speed of the motor. It is therefore also an ideal starter type, both for reduction of the locked-rotor current and for reduction of pressure surges.

Note: a low frequency produces slow impeller rotation, reducing pump performance.

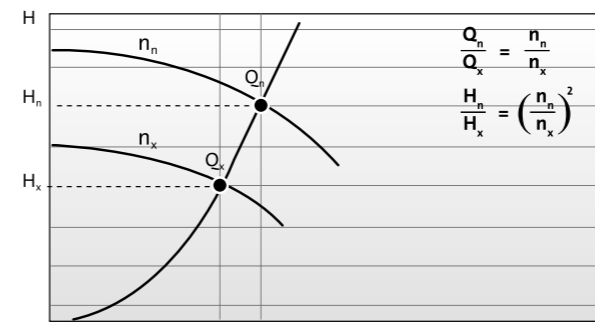

Fig. 39 Pump performance with different frequencies

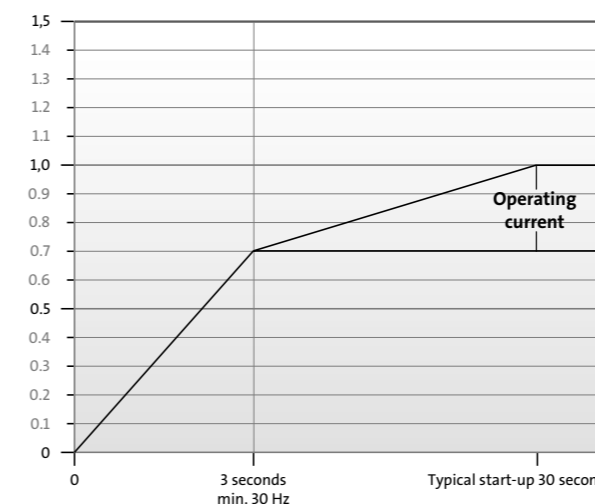

Fig. 40 Current flow by frequency converter starting

Frequency converters are the most expensive of the above-mentioned starting devices, and will primarily be used in connection with operation at variable performance.

There are several types of frequency converters on the market, each having its own characteristics. A brief overview is presented here:

- The simplest frequency converter is based on a voltage frequency curve. This converter is sometimes called an U/f or V/f converter. They calculate the actual output voltage from the frequency, without taking the actual load into consideration. Different U/f or V/f curves can be chosen to optimise for the actual application. Pumps will typically use the Variable Torque curve. These fre-

quency converters are the cheapest on the market, and are often employed.

- The next step is the Vector-Controlled frequency converter. This frequency converter uses a model of the motor, and calculates the output voltage based on several parameters including the actual load. This gives higher performance in controlling the shaft of the motor, such as a higher accuracy of min-1, torque, etc. These drives are more expensive than the U/f based drives, and are typically used for industrial applications. However, they are also used in systems where instabilities often occur. The more precise way of controlling the shaft normally eliminates the problems caused by an instable pump. The vector-controlled drives usually have a higher efficiency, or an automatic energy optimizer function.

The output section of a frequency converter can be made in two different ways: either with six or with 12 transistors.

This can also be referred to as 6-pulse and 12-pulse inverters. Six transistors are the most commonly found solution, as it is the cheapest and the simplest way of creating an output stage. To reduce the stress on motor insulation and increase the control performance, the 12-transistor output stage was introduced. 12-transistor operation is typically combined with advanced controls that are based on flux models of the motor. The advantage of a 12-transistor solution usually includes improved control at low speeds and less stress on the motor. A 12-pulse frequency converter lies in the expensive range of frequency converters.

The main selection factor for combining frequency converter and pump is the full load amps including the overload factor. The frequency converter should be chosen so it can deliver the required current all the time. For example, if the motor requires 9.7 A, chose a frequency converter with an output current at 9.7 A or higher.

5.5 Operation with frequency converter

There are several things that should be considered when using frequency converters together with submersible motors. Some of the conditions for running submersible motors on frequency converters are found below.

1a. The frequency converter must have some kind of output filter to limit voltage peaks (U_{peak}) and to reduce dU/dt (or dV/dt) which causes stress on the insulation of the submersible motor. The maximum voltage (U_{peak}) should be reduced to a level of less than 850 V (except for the MS 402); dU/dt should also be limited in accordance with the following table.

Max peak voltage and max dU / dt for Grundfos submersibles		
Motor series	Max. U_{peak} voltage	Max. dU / dt
MS402	650 V Phase - Phase	2000 V / micro s.
MS4000	850 V Phase - Phase	2000 V / micro s.
MS6/MS6000	850 V Phase - Phase	2000 V / micro s.
MMS6/MMS6000	850 V Phase - Ground	500 V / micro s.
MMS8000	850 V Phase - Ground	500 V / micro s.
MMS10000	850 V Phase - Ground	500 V / micro s.
MMS12000	850 V Phase - Ground	500 V / micro s.

The typical output filters for frequency converters are LC (also called sinus filters) or RC filters. Frequency converter suppliers can supply data regarding U_{peak} and dU/dt for their different frequency converter series. Please see chapter 5.6.

Normally, filters are also required if long motor cables are to be used together with the frequency converter.

The U_{peak} and dU/dt values should be measured on the motor terminals.

See table above for acceptable values of dV/dt .

1b. Frequency converters are normally designed for use in an industrial environment. If a frequency converter is used in residential areas, it might be necessary to add some kind of input filter to pre-

vent electrical disturbances from the frequency converter from affecting other equipment on the same mains. Normally there are three different levels of filters to select among:

- No filter (Only for industrial use where filtering is done elsewhere)
- Filters for industrial applications
- Filters for domestic applications.

The version for domestic applications can be an add-on for the industrial application, or it can be a separate version.

It is mandatory to fulfil the requirements in the manuals for the frequency converter for keeping the CE mark on the product. If this is not done properly the CE marking is not allowed.

2. The flow rate past the motor must be at least 0.15 m/s. The motor must be fitted with a cooling sleeve if the pumping does not create sufficient flow past the motor.
3. With control of submersible motors in open systems with high static lift, the power consumption will change only moderately. This means that a reduction of the pump performance will give increased generation of heat in the motor. A reduction of the motor lifetime must therefore be expected. For operation with a frequency converter, Grundfos therefore always recommends using a motor with spare capacity, i.e. an industrial motor or a derated standard motor.
4. The motor frequency:
 - min.: 30 Hz
 - max.: 60 Hz
5. Temperature protection of Grundfos submersible motors with frequency converter is possible for motors with a built-in thermocontacts. The motor temperature cannot be read, but the protection is the same. An additional cable is required for the motor, but as operation of submersible motors by means of frequency converters is usually used in connection with tank application, this will not cause disturbances or additional costs.

If the points discussed above are met, the motor will have an acceptable lifetime.

Please note that external frequency converters result in power loss and transmits transients, they will:

- generate more heat in the motor compared to direct on line operation
- reduce the motor efficiency
- increase the power consumption of the motor.

Because of this, an industrial motor should always be used, as it has been built to compensate for these disadvantages.

As far as the operating economy is concerned, the following should be taken into consideration:

- Frequency control of deep well submersible pumps will normally not result in improved operating economy when installed in a well.
- It does, however, reduce the need for large tanks and space for these.
- Frequency control of raw-water pumps reduces pressure surges in the pipe system and variations of the water level in the well at pump start and stop.

However where some kind of control is needed such as constant pressure, constant well water level, or similar, there might be different levels of improvement in using frequency converters. A frequency converter includes some logic input and output. It also typically includes a PID control section, for establishing control of the application. In many cases additional equipment can be omitted, and the use of the frequency converter as a starter and as a part of the control system will improve the overall economic perspective.

The PID controller is widely used in control applications, and frequency converter manufacturers normally gives some hints about how to optimize the use of this feature.

Please be aware of that an incorrectly programmed PID controller could lead to an instable performance and excessive pressure on the system.

Please note that the ramp-up time to a minimum frequency of 30 Hz may not take longer than 3 seconds.

5.6 CUE variable speed drive for SP pumps



Fig. 41 CUE family

CUE is a Grundfos frequency drive with a logical interface for easy setup and operation.

With a CUE, it is possible to control pump performance by changing the frequency. This allows you to program a smooth start up and stop of the pump. This minimises the risk of damages on the pressure pipe and the entire pressure piping system. It also reduces the stress from water hammer while minimising the costs for valves and other regulating devices.

Operation below 30 Hz is acceptable for no more than three seconds. Above 30 Hz, there is no limitation regarding operation time. This must always be observed however, both during ramp-up and ramp-down sequences.

The max. frequency is 60 Hz.

The set-up data for the CUE is always current, and not kW, since submersible motors are often different from norm motors.

Functions

The CUE allows you to maintain the following parameters:

- Constant pressure
- Constant level
- Constant flow rate
- Constant temperature
- Constant curve.

Power cable

A submersible pump power cable in a screened version is not available. Normally, it is not required according to the EMC regulations due to the submerged installation.

Mains cable

This cable runs from the mains supply to the CUE unscreened. The cable between CUE and filter is screened. The cable running from the filter to the pump motor is normally unscreened. The two examples illustrate these setups.

If the cable is used outside the well in a dry environment, a screened cable may be used with a cable connection to the submersible pump cable at the well head. fig. 42 below shows how a cable selection can be used together with CUE and a filter. In the second example, the connection box is located at the well head.

Further information may be found in webCAPS on www.grundfos.com.

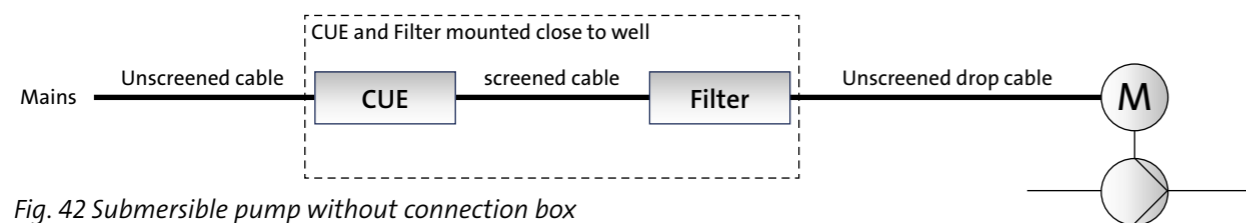
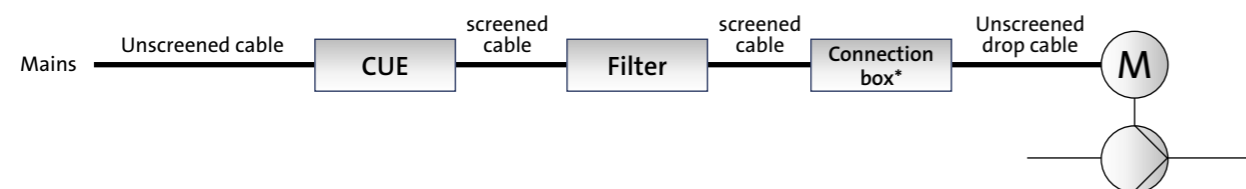

Fig. 42 Submersible pump without connection box



* Both ends of the screened cable from the filter to the connection box must be connected to earth

Fig. 43 Submersible pump with connection box and screened cable

Filter selection

Fig. 44 below shows how to select the correct filter for the installation.

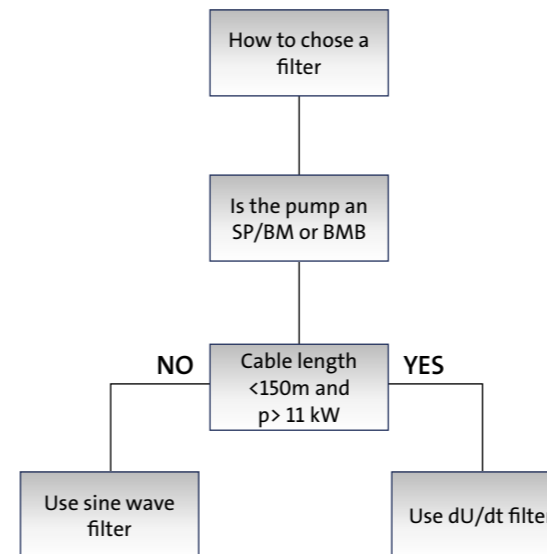

Fig. 44 Setting guidelines

The main difference between dU/dt filters and sine wave filters is:

Both filters consist of coils and capacitors. The coils and the capacitors are small in value in the dU/dt filters compared to the values used in sine wave filters.

Grundfos offers a full range of filters to be used with CUE.

Setting guidelines

- Ramp (up and down): maximum 3 seconds. This is to ensure the lubrication of journal bearings to limit wear, and prevent the winding from becoming burnt out.
- Use temperature monitoring by PT100 (use of screened cable can be needed).
- Heat kills the motor => low isolation resistance => sensitive to voltage peaks.
- Motor recommendations:
 - For MS: use motors with 10% extra in given duty point.
 - For MMS: always use motors that are PE2 – PA wound.
- Remember to use a LC filter.
- Reduce peaks to max. 800 V.
- Grundfos recommend Danfoss frequency inverter, in combination with a LC filter.
- Cables act as amplifiers => measure peaks at the motor.
- Dimension it with respect for the current and not the power output.
- Dimension the cooling provision for the stator tube at duty point with lowest flow rate. The minimum flow m/s along the stator housing must be considered.
- Assure that the pump is used within the intended range of the pump curve.
- Focus on the discharge pressure and sufficient NPSH, as vibrations will kill the motor.



6.1 Power generation

The following will only focus on alternating current (AC) as this is the primary source of power for asynchronous motors.

Distribution

In order for generated power to be useful, it must be transmitted from the generating plant to the area where consumption takes place. The challenge is to have sufficient amount of energy available at the time and place where work is demanded.

The most efficient way to transfer energy from generating plant to consumption places is to increase voltage while reducing current. This is necessary in order to minimize the energy loss as consequence of transmission. These losses are referred to as $I^2 \times R$ losses, since they are equal to the square of the current times the resistance of the power lines. Once the electrical energy gets near the end user, the utility will need to step down the voltage to the level needed by the consuming machine. Each time, the voltage level is changed, energy is lost, even in the most efficient transformers.

6.2 Voltage

6.2.1 Voltage unbalance

Submersible motors are designed to operate on power lines with given voltage and frequency.

Voltage unbalance can be regulated at the regulating board of the transformer and/or the generator. The voltage unbalance shall be kept as small as possible, as it is the primary source of current unbalance. This leads to the creation of additional heat in the motor.

One possible cause of voltage unbalance is the unequal distribution of single phase loads. These loads vary over time. Voltage unbalance is subsequently very difficult to avoid if the net contains high percentage of single phase consumption.

Use of two single phase transformers in so called "open delta" connection is not recommended for three phase supply.

6.2.2 Overvoltage and undervoltage

Power lines are expected to deliver a specific voltage. Near the low voltage transformer, there will often be an overvoltage of 3-5%. When the power lines are loaded, a voltage drop will occur due to ohmic resistance in periods of peak power consumption.

Most power lines are dimensioned so that undervoltage of more than -10% will occur less than once a year at the weakest point. But many consumers still experience periods of considerable voltage drop.

Any motor will suffer if it does not receive the voltage stamped on the nameplate. If the voltage drops, the motor torque will be reduced and the speed of the loaded motor will consequently be reduced, too.

As a result of this, the efficiency and induction resistance of the motor will drop. This will make the power consumption increase, resulting in increased generation of heat in the motor.

When a fully-loaded centrifugal pump motor receives 10% undervoltage, the power consumption will increase by approx. 5%, and the motor temperature by about 20%. If this temperature increase exceeds the maximum temperature of the insulation material around the windings, these will be short-circuited and the stator will be destroyed. In the submersible motor, the temperature of the motor liquid is very important for the lubrication of the journal bearings. The load capacity as function of the temperature can be seen on the diagram below.

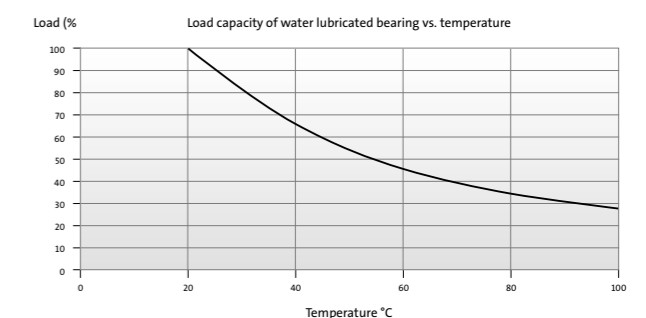

Fig. 45 Diagram: Journal bearings load capacity as function of motor liquid temperature.

6. Power Supply

This is critical if the motor is placed in a hot environment and is badly cooled, or in case of voltage asymmetry, current asymmetry or voltage transients at the same time.

Usually, an increased winding temperature caused by undervoltage will lead to faster aging of the insulation, resulting in a reduced life.

In case of overvoltage from the grid, the power consumption and heat generation in the motor windings will increase as well.

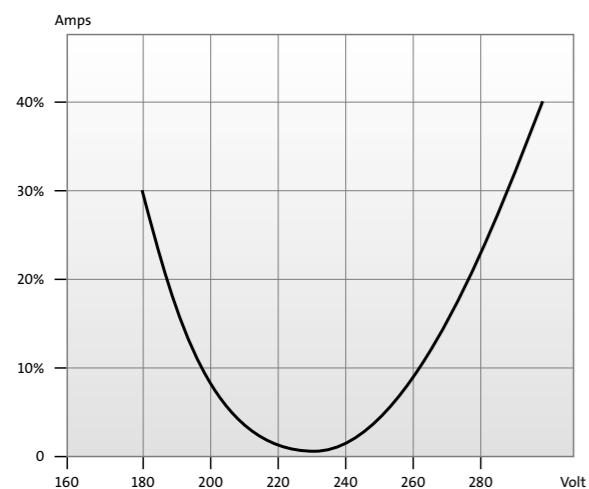

Fig. 46 Current variation as a function of over- and undervoltage on a 230 V motor.

Conclusion

1. For voltage variations of +6/-10% of the rated value, measured at the motor terminals, normal life can be expected when the power consumption is equal to or less than the rated current stamped on the nameplate and if the motor cooling is sufficient and no transients or asymmetry occur.
2. For short/periodic voltage variations exceeding +6/-10% of the rated value, the reduction in life will be moderate until undervoltage/overvoltage variations are so considerable that the stator windings are short-circuited.
3. With permanent or long lasting voltage variations exceeding +6/-10%, the motor should be derated or a Grundfos oversize motor chosen in order to obtain acceptable life and efficiency. Control of motor temperature is by use of Grundfos MP 204 electronically motor protector is always recommended.

It is customary to derate a standard motor to ensure long life if overvoltage or undervoltage of more than +6/-10% can be expected at the motor cable entry. Single-phase motors will often require capacitor adaptation when exposed to low voltage supply.

6.3 Frequency

The frequency should always be kept at the nominal value. If the frequency is higher, the pump may overload the motor. If the frequency is lower, pump performance will drop.

6.4 Variable frequency drives

In order to make rational electric power distribution utilities have agreed to use same frequency. This enable direct connection of different nets under condition that the frequency and sequence of this is the same. The dominant frequencies used in the world today are 60 Hz and 50 Hz.

The frequency determines the speed of an asynchronous motor. Unfortunately it is very difficult to calculate exactly the speed of an asynchronous motor. This is determined by the speed of a synchronous motor minus the slip.

Slip is defined as the difference in speed between rotor and stator field. The slip is the product of the resulting torque – this means the greater the load, (torque) the greater the slip. In other words, the slip of an asynchronous motor is load dependent.

The synchronous speed can be calculated by use of following formula:

$$N_s = \frac{120 \times f}{P}$$

- Ns = the speed of the rotating magnetic field.
- 120 = constant.
- f = frequency.
- P = number of poles.

Variable frequency drives (VFDs) are used to create a “new” local net with a frequency different from what the supply company is providing. This allows the frequency and the motor (and pump) speed to be regulated.

Modern frequency drives can regulate in an interval between 0 and 400 Hz (or even more). Please remember, as the speed goes up the load is also increasing eventually leading to risk of overloading the motor if not dimensioned correctly.

Another important issue to remember is that the frequency drive must not be used to boost voltage. When you regulate the voltage, the frequency must remain constant.

Practical example:

Given net = 400 V, 50 Hz
 In order to have bigger regulation area, you choose to dimension the pump set for 60 Hz operation. This gives recommended regulation area from 30 – 60 Hz. Hence you are not to boost voltage you have to choose a motor suited for running at 400 V, 60 Hz (practically this will lead into choosing a 380 V, 60 Hz motor hence this is a standard).

Filters:

Variable frequency drives is based on a technology that switches (chops) in and out the voltage. This means that the resulting output from a variable frequency drive is only partly a sinusoidal curve. The result is generation of noise on primary as well as secondary side of the variable frequency drive. The primary side is regulated by authorities and/or utilities and demands RFI filter solutions. On the output side, the challenge is the length, the type, the size and how the cables are placed in the installation. Long cables increase the risk of creating high voltage peaks leading to deterioration of the insulation system of the submersible motor.

Grundfos recommends the use of LC filters on the secondary side of all variable frequency drives. If the supplier of a VFD with a given cable configuration will issue assurance that Upeak for given motor is not exceeded at motor terminals this can be accepted. See the table on page 42.

Current:

Please note that dimensioning of variable frequency drives is done from the current value of the motor – and that a submersible motor has higher current values than similar output surface motor.

6.5 Grid connection

Before connecting to grid, the characteristics of the grid shall be known: How is the quality of the net, what kind of earth is used and how good is the surge and lightning protection?

- What voltage will be supplied and with what tolerances?
- What frequency will be supplied and with what tolerances?
- What power is at disposition?
- How often can grid disturbances be expected?
- Is an own transformer foreseen or will a common transformer be used? If a common transformer is used, ask how even load of the net is assured (only applicable for 3-phase motors).

The supply from the grid to the motor is normally referred to as the net supply. Net supply is the power line having the voltage for machine uses. Net quality we divide into so called “stiff” or “soft” net.

A given grid voltage is transformed into appropriate net voltage by use of a transformer. The cheapest way of transforming a given grid voltage into appropriate net voltage is done through a so called autotransformer. Please note that this is not possible in all countries.

In order to protect the submersible motor, you need a device that can isolate the motor from the net/grid supply in case of problems. Grundfos recommends the use of electronic motor protector device MP 204.

6.6 Current asymmetry

Low current asymmetry gives the best motor efficiency and longest life. It is therefore important to have all phases loaded equally. Before measuring takes place, it should be checked that the direction of rotation of the pump is correct, i.e. the one which gives the highest performance. The direction of rotation can be changed by interchanging two phases. The current asymmetry should not exceed 5%. If there is a MP 204 connected, 10% will be acceptable. It is calculated by means of the following two formulas:

$$I (\%) = \left(\frac{I_{\text{phase max.}} - I_{\text{average}}}{I_{\text{average}}} \right) \times 100 [\%]$$

$$I (\%) = \left(\frac{I_{\text{phase}} - I_{\text{average min.}}}{I_{\text{average}}} \right) \times 100 [\%]$$

The maximum value is used as an expression of the current asymmetry. The current must be measured on all three phases as illustrated below. The best connection is the one which gives the lowest current asymmetry. In order not to have to change the direction of rotation when the connection is changed, the phases must always be moved as illustrated. MP 204 makes it possible not only to protect against too high a current asymmetry, but also to have readouts of the actual values if used with an R100. This makes it easy to find the optimal connection.

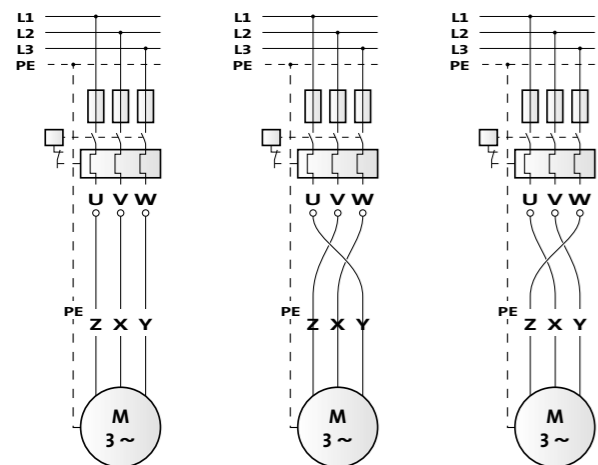

Fig. 47 Optimal connection

Example

See the diagram in fig. 45 and the table below.

Step 1	Connection 1 UZ 31 A VX 26 A WY 28 A Totally 85 A	Connection 2 Z 30 A X 26 A Y 29 A Totally 85 A	Connection 3 Z 29 A X 27 A Y 29 A Totally 85 A
Step 2	Average current: $\frac{\text{Total current}}{3 \times 3} = \frac{85 + 85 + 85}{3 \times 3} = 28.3 \text{ A}$		
Step 3	Max. amps. difference from average: Connection 1 = 31 - 28.3 = 2.7 A Connection 2 = 28.3 - 26 = 2.3 A Connection 3 = 28.3 - 27 = 1.3 A		
Step 4	% unbalance: Connection 1 = 9.5 % - no good Connection 2 = 8.1 % - no good Connection 3 = 4.6 % - ok		
Step 5	If the current unbalance is greater than 5%, the power company should be contacted. As an alternative, a derated or industrial motor protected by an MP 204 should be used. On the remote control, you will be able to read the actual current asymmetry. A current unbalance of 5% corresponds to a voltage unbalance of 1-2%.		

Even a small voltage unbalance gives a large current unbalance. This unbalance, in turn, causes uneven distribution of heat in the stator windings leading to hot spots and local overheating. The key results are illustrated graphically below.

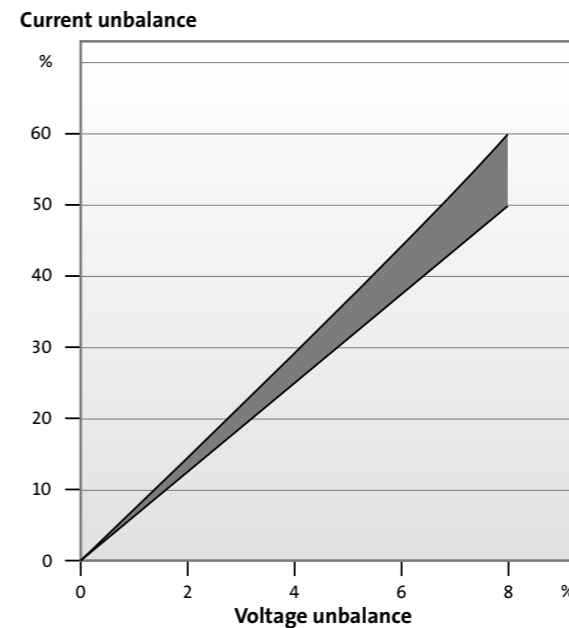

Fig. 48 Relationship between voltage and current unbalance

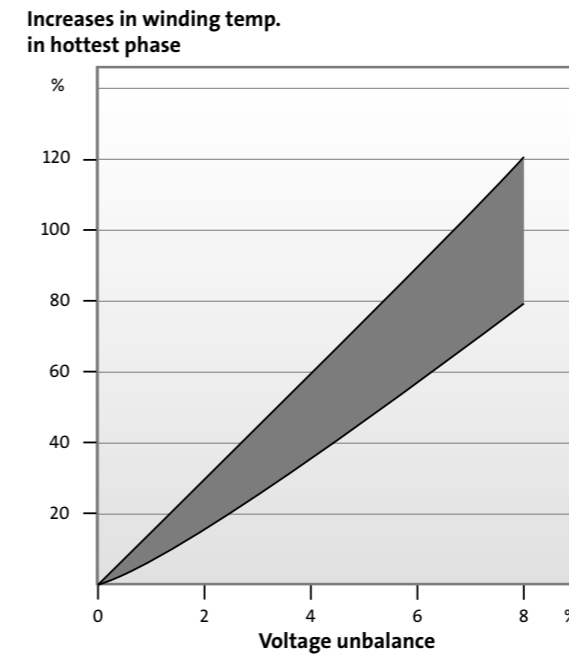

Fig. 49 Relationship between voltage unbalance and temperature

Current unbalance can be created by the positioning of the drop cables. If jacketed cables are used, no problems should be expected. If single lead is used it is always recommend to place the three phase con-

ductors on one side of the riser pipe and then have the earth lead diagonally opposite.

Voltage transients / lightning

Power lines are supposed to deliver sinusoidal shaped waves on all three phases. The sinusoidal shaped waves produced at the power station are added to the transients in the distribution system.

Sources of transients:

1. Frequency converters without filters
2. Soft starters
3. Contactors for big machines
4. Capacitors for process machines
5. Lightning

1. **Frequency converters without filters** Modern frequency converters with an LC or RC filter can be protected so that they do not produce voltage peaks above 850V in connection with cables of up to 100m between frequency converter and motor. This is fully acceptable and any Grundfos motor with correct rating and cooling will have an acceptable life. Frequency converters of the PWM type (Pulse Width Modulation) without LC or RC filter yield an output voltage which differs much from the ideal sinusoidal curve with transients of 600V at 400V mains and dU/dt: 2000-2400V/us, measured at a cable length of 1m, depending on the make. These transients will increase with increasing cable length between frequency converter and motor. At 200m, for instance, the transients will be double at the motor cable plug, i.e. U_{peak} equals 1200V and dU/dt: 1200V/us (400V mains). The result will be reduced lifetime of the motor. Because of this, frequency converters must at least contain an RC filter to ensure optimum motor life.

2. A connected soft starter will absorb a non-sinusoidal current and give rise to a certain grid noise. In connection with very short acceleration/deceleration times, this is of no practical importance and does not conflict with regulations concerning grid noise. If the start-up time is longer than three seconds, the non-sinusoidal transients will overheat the motor windings and consequently affect the lifetime of the motor.

3. Big machines starting DOL or in star-delta connection may create sparks and send considerable transients back to the grid when the contactors are opened. These surges can harm the submersible motor.
4. Phase compensation of process plants may contain complicated controls with many and big capacitors which send surges back to the grid. Surges can be harmful for submersible motors.
5. A severe stroke of lightning directly on a well installation, starter or power supply will generally destroy all living organisms and all electrical installations. The transients from such a stroke of lightning will be at least 20-100 kV and the generation of heat enough to melt the insulation materials. Lightning striking the grid will generate transients which will partly be absorbed by the lightning arresters in the grid system. The function of a lightning arrester is to leak the overvoltage to earth. If a low-voltage grid is hit directly by lightning there is a risk of transients of more than 10-20 kV at the pump motor starter. If starter and motor are not correctly protected by lightning arresters and earthing, the installation may be damaged, as it is installed in electrically conducting groundwater, which is the best kind of earthing there is.

Damage to submersible motors from lightning may arise both in connection with power supply through overhead cables and underground cables. In areas with frequent lightning, the best protection of both starter and submersible motor is to install lightning arresters on the discharge side of the starter main switch and connect them to grounding rods or if possible to the riser main of the well if this is made of steel.

At the borehole, lightning arresters should be fitted on the discharge side of the isolation switch grounded to the riser main and the well casing if made of steel. For deep installations, lightning arresters can be fitted in the motor cable, too, as transients double the voltage in a 200m drop cable. But in general, lightning arresters should be positioned so that their function can be checked by periodic megging as they wear out when exposed to much heavy lightning.

If the power supply suffers from heavy lightning transients, call the power company to have them test their lightning arresters at the transformer station.

If a system has been exposed to lightning, all components in the starter box should be thoroughly tested. The contactor may be burned on one phase which may give rise to voltage and current unbalance in the motor. The contactor or the thermal relay can be burned on several phases which may cause both undervoltage and unbalance. The thermal relay may be burned which means that it cannot trip and consequently cannot protect the motor windings. Only some of the motors which are damaged by lightning are destroyed by the stroke itself; the rest are damaged by consequential effects. Grundfos submersible motors type MS 402 have an insulation level of up to 15 kV. This is the maximum voltage peaks, which the motor is exposed to in practice, e.g. in connection with lightning close to the installation. Lightning directly on the pump installation is excluded here. Additional lightning protection is therefore not necessary.



7. Installation & operation

7.1 Wells and well conditions

A well is a hole, stretching from the surface of the earth to the underground aquifer, where the groundwater is found. The depth of the well may vary from a few meters to several hundred meters.

Wells are typically drilled with special drilling equipment, which is able to penetrate the various layers of the ground, such as sand, clay, bedrock, etc. Inside the drilled hole a casing (pipe) is typically installed, which prevents the well from collapsing around the pump.

Below the casing, and in line with the aquifer, is another 'casing' with fine slots. This is the well screen, where the slots allow the water to enter the well. It holds back sand and larger particles trying to enter the well. See fig. 50.

To improve the filtering function, the borehole typically features a diameter that is 2-3" larger than the casing. A fine sand gravel pack filter is placed between the casing and the aquifer, as shown in fig. 45. Some casings come with a pre-made gravel pack filter. Made correctly, this filtering method prevents sand and silt from entering the well.

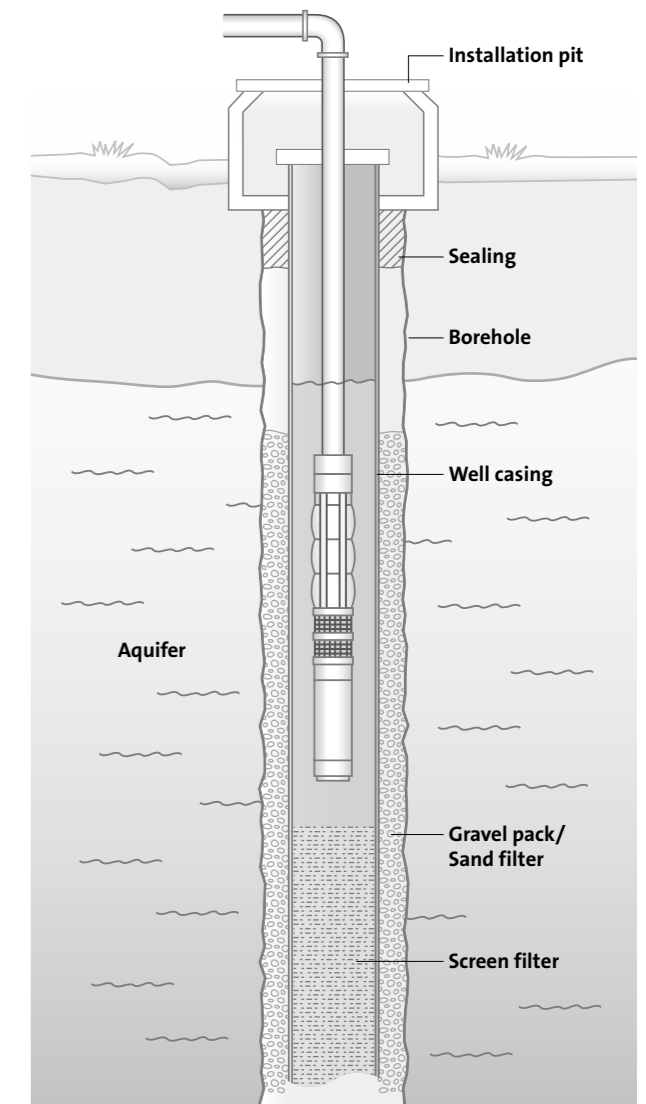

Fig. 50 Typical groundwater well components

Recommendations on sand content varies from one country to another.

The National Ground Water Association (NGWA) in USA recommends the following sand limits in well water:

- 1.10 mg/l in water used for food and beverage processing.
- 2.50 mg/l in water for private homes, institutions and industries.
- 3.10 mg/l in water for sprinkler irrigation, industrial evaporative cooling and other applications where a moderate content of solids is not particularly harmful.
- 4.15 mg/l in water for flood irrigation.

If the concentration of sand exceeds 15 mg/l, so much material will be removed from the well that the aquifer and the strata above it may collapse and thus shorten the life of the well.

Grundfos permits a sand content of no more than 50 ppm in the well water. With a sand content of 50 mg/l, the pump efficiency and the lifetime will remain acceptable for up to 25,000-35,000 duty hours, equal to approx. four years of operation for eight hours a day.

If the well water has a sand content higher than 50 mg/l, a special pump and motor is available on request.

Before the well can be put into operation, it must be developed. A new well will always produce some sand and silt in the beginning, and well development is the process of pumping a new well free from sand and silt. It is done by pumping with a very high flow, which draws the fine particles in the aquifer into the filter of the well. This slowly makes the filter more effective. After approximately one day of pumping, the well is normally pumped clean, and is ready for normal operation.

The pump used for well development wears out relatively quickly because of the high sand content, and it should therefore always be replaced with a new pump as soon as the well does not produce any more sand.

The pump must always be installed above the screen area of the casing. In this way, you ensure that the water is forced past the motor, providing adequate motor cooling. If the pump can not be installed above the screen filter, a cooling sleeve is always recommended to create the necessary flow along the motor for proper cooling. See chapter 10.

7.2 Pump setting

Pump setting is the depth at which the pump has been installed beneath the ground. The pump must be able to lift the water from the aquifer to the surface and deliver a certain minimum pressure.

When the pump is installed, the drawdown and the dynamic water level must always be known. During operation, the water must never fall below the inlet of the pump. The risk of cavitation is normally very small with submersible pumps. However, NPSH of the specific pump in its duty point, should always be checked.

Minimum pump inlet submergence in meters: $NPSH(m) - 10(m)$.

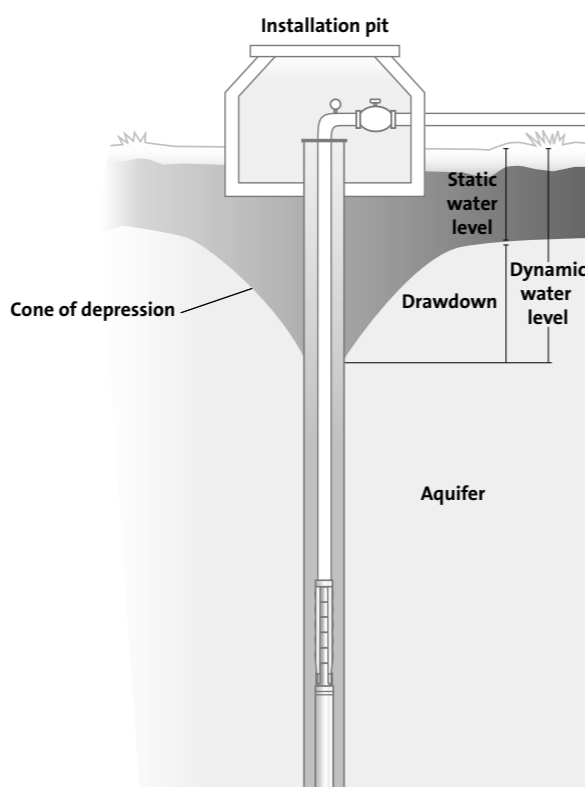

Fig. 51 Static and dynamic water level

7.3 Pump and motor selection

Please see chapter 4 for sizing and selection of submersible pumps.

7.3.1 The duty point

The duty point of the pump is the flow where pump efficiency is best. The pump must be selected so the required flow is as close as possible to the duty point, or slightly to the right of the duty point.

7.3.2 Well diameter

In general, the larger the diameter of the pump, the higher the efficiency.

However, the pump must be able to fit into the well, and a certain minimum clearance between motor surface and internal well diameter is therefore always required.

In a correctly designed well, with the well screen below the pump and motor, the water has to pass the clearance between the casing and the motor. This will cause a friction loss.

If at the same time the motor is eccentric positioned in the well with one side against the casing, the single sided inlet of water into the pump will create turbulences and affect the performance of the pump.

Fig. 52 shows the friction loss for clearance from 4 to 16 mm in a 6" well, and fig. 53 is showing the same for a 8" well.

Both the turbulence and the friction loss will result in pump underperformance, which in some situations can be extreme.

In wells with well screen area positioned above the pump, the water has to pass the clearance between the pump and the casing, which will cause a friction loss.

If at the same time the pump is positioned eccentric against the casing, it will restrict the inflow at half of the suction interconnector. This single sided U-turn of inlet water will create inlet turbulence affecting the function of the pump.

Fig. 54 shows the worst case turbulence/friction loss at 6" pumps in 6" wells of different diameters .

Fig. 55 shows the worst case turbulence/friction loss at 8" pumps in 8" wells of different diameters.

The turbulence and friction will be seen as underperformance of the pump.

7.3.3 Well yield

Many pumps are able to overpump the well, which means it will run dry in a short period of time. The pump must be selected with due respect to the capacity of the well, so overpumping is avoided. We therefore recommend monitoring the water table.

Several problems may arise from overpumping:

- Dry running and pump damage
- Infiltration of non-potable water, i.e. seawater
- Chemical reactions in the well when oxygen contacts the dry aquifer.

Excessive drawdown also triggers increased power consumption, since it must be compensated with additional pump lift.

7.3.4 Pump efficiency

All pumps have their peak efficiency over a relatively narrow flow range. This range is normally used to select the pump. A Grundfos SP46 has its peak efficiency at and around 46 m³/h flow, just as SP60 lies around 60 m³/h, and so on for all other SP pumps.

If the flow requirement falls between two models, i.e. 66 m³/h, both an SP60 and an SP77 may be used with the same efficiency. Some of the other criteria come into play as a result:

- Well diameter (see chapter 7.3.2)
- Well yield (see chapter 7.3.3)
- Spare capacity.

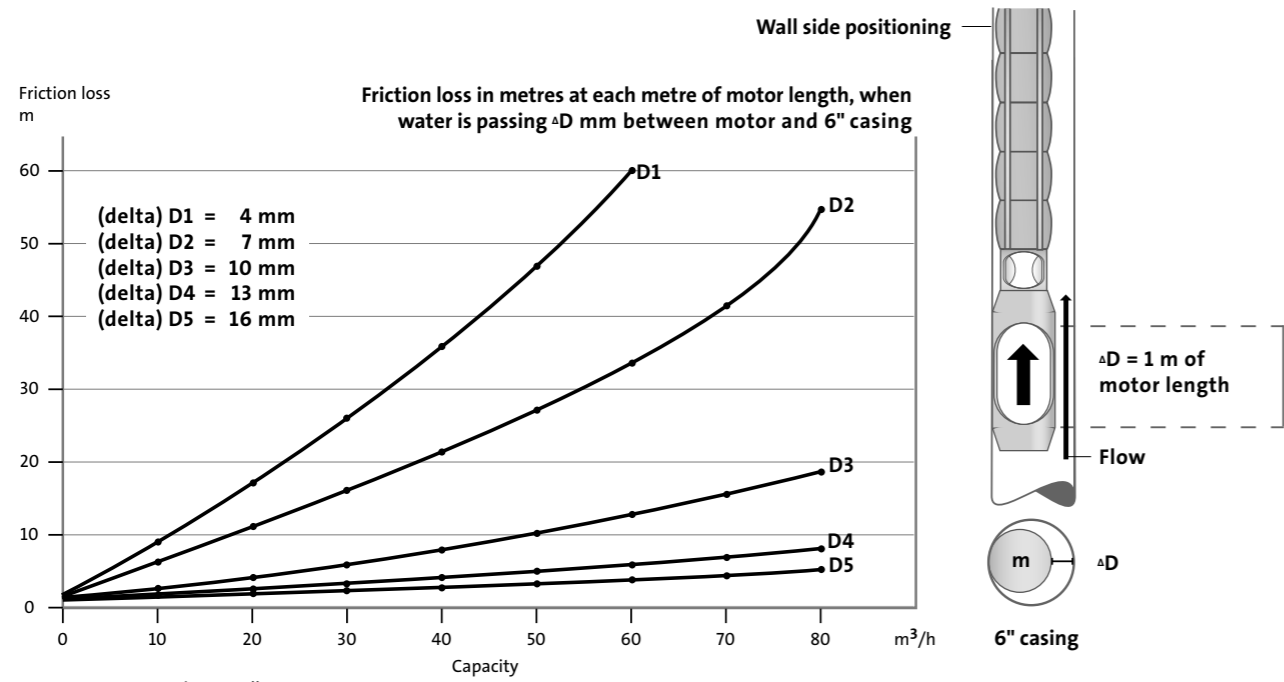

Fig. 52 Friction loss, 6"

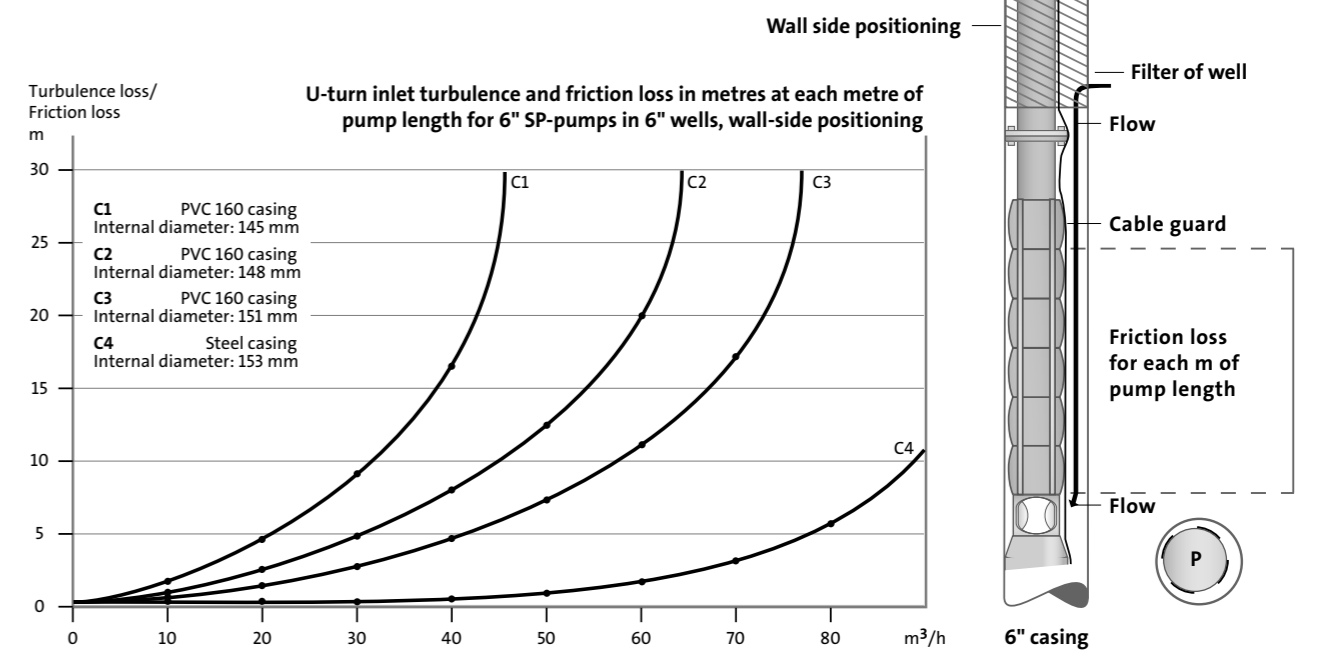

Fig. 54 U-turn, 6"

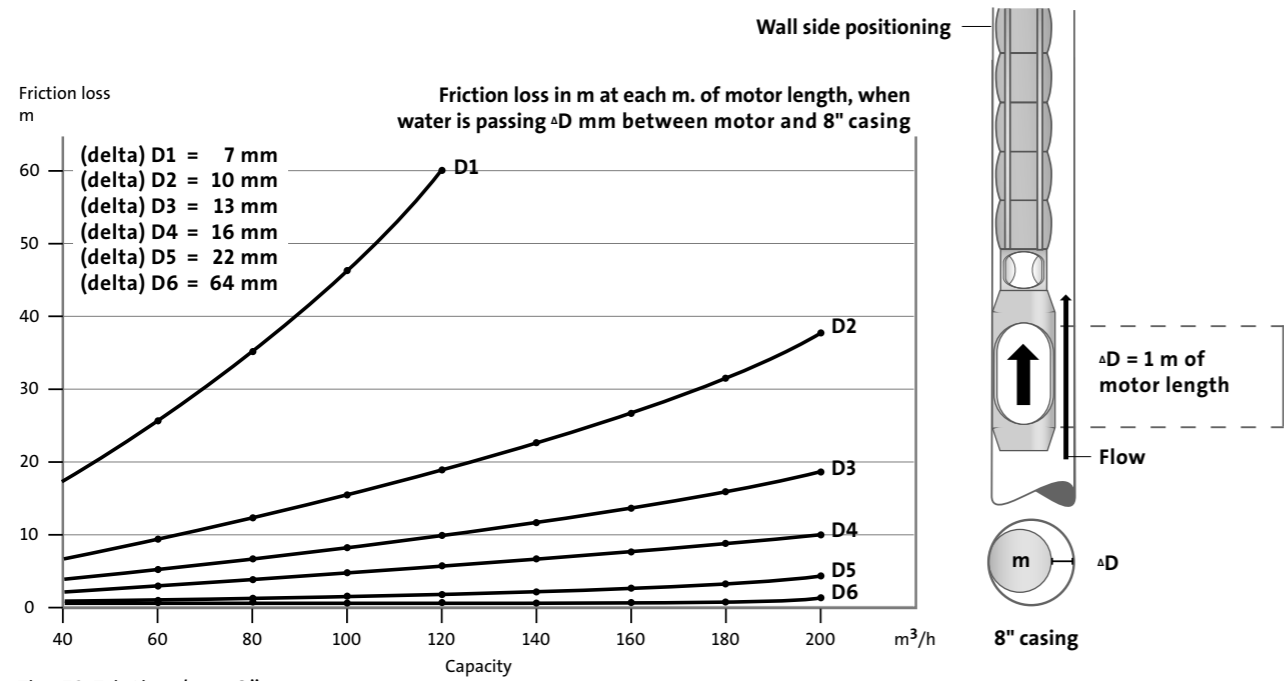

Fig. 53 Friction loss, 8"

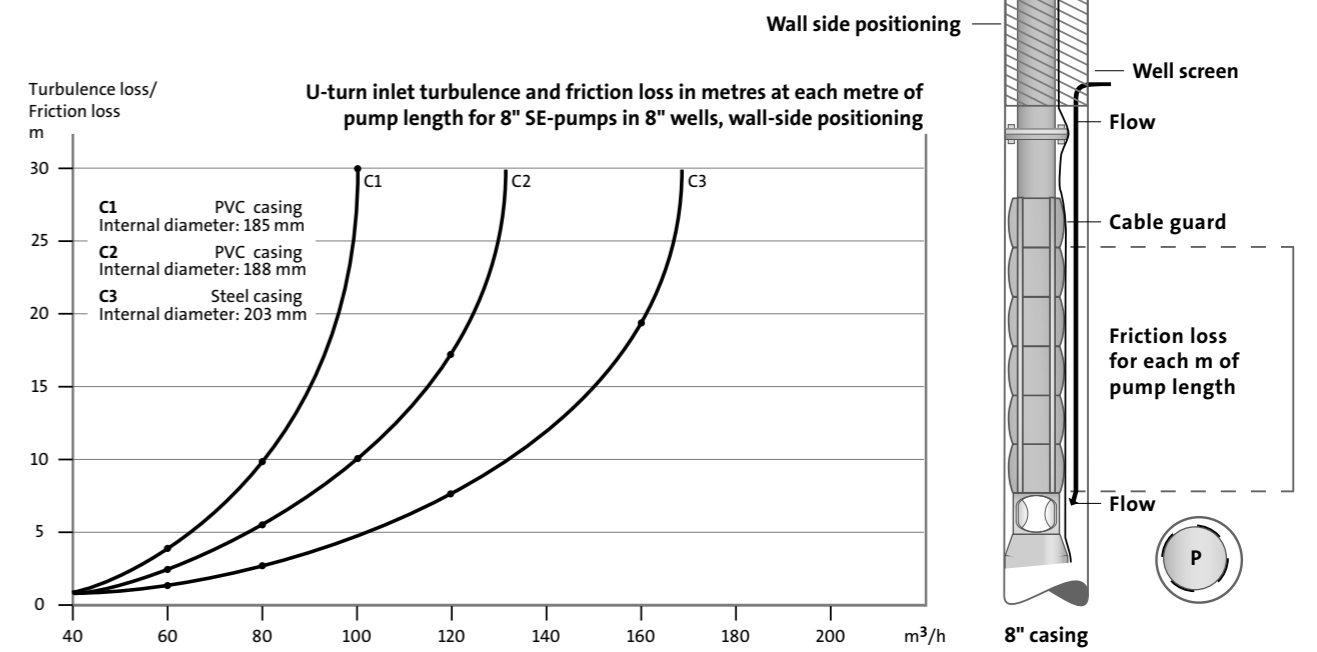

Fig. 55 U-turn, 8"

7.3.5 Water temperature

The limiting factor is the submersible motor and cooling of the motor. Cooling is the key to a long lifetime of the motor.

Submersible motors installed at maximum acceptable water temperature must be cooled at a flow rate of at least 0.15 m/s, which ensures turbulent flow. This velocity is ensured by not letting the pump flow drop below a certain minimum value. See fig. 56.

In large diameter wells or tanks it may be necessary to use a flow sleeve to increase the flow along the motor to minimum 0.15 m/s. See chapter 10 as well.

In the diagram below, the motor is assumed to be positioned above the screen setting.

Maximum water temperature:

The maximum temperatures shown below are based on flow along the motor of 0.15 m/s

MS 402	30 °C
MS 4000	40 °C
MS 4000I	60 °C
MS 6000	40 °C
MS 6000I	60 °C
MS6T30	30 °C
MS6T60	60 °C
MMS with PVC wire:	25 °C
MMS with PE2/PA wire:	40 °C

Water temperatures above the temperature limit Grundfos MS 402 motors must not be used at liquid temperatures above 30 °C. Operation with MS 4000 and MS6 is possible at a liquid temperature above the given temperature limit, if the motor is derated (See fig. 57 in chapter 7.3.6).

In general, however, this will shorten the life of the motor. It is impossible to say by how much, as this depends on a number of other parameters, e.g. the voltage supply, motor load, motor cooling conditions, etc. Following the recommendations in this manual however, should provide an acceptable lifetime.

In these cases, we recommend that the pump is serviced and all rubber parts replaced every three years in order to keep constant efficiency and ensure a normal lifetime.

At operation above the temperature limit, warranty issues must always be agreed upon. No warranty can be given without derating and MP 204 protection.

7.3.6 Derating of submersible motors

Multiply the motor size (P2) with the derating factor. This gives the derated motor output P2. That is the maximum load that may be applied on the motor. In many cases this results in a motor that is one size bigger than originally calculated.

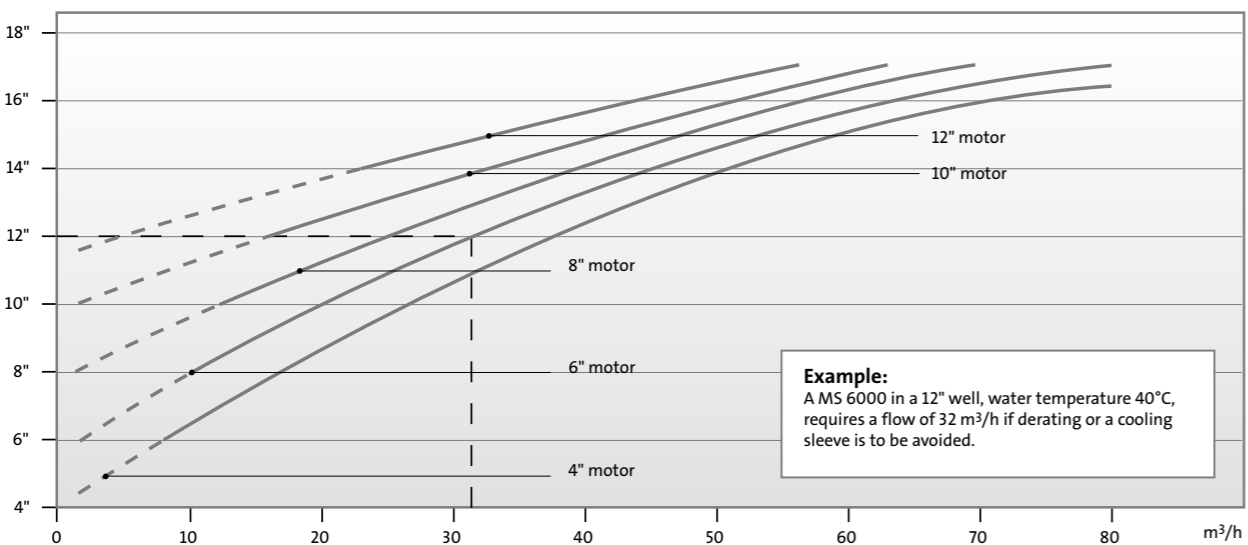

Fig. 56 Maximum full-load cooling water temperature

Derating factors

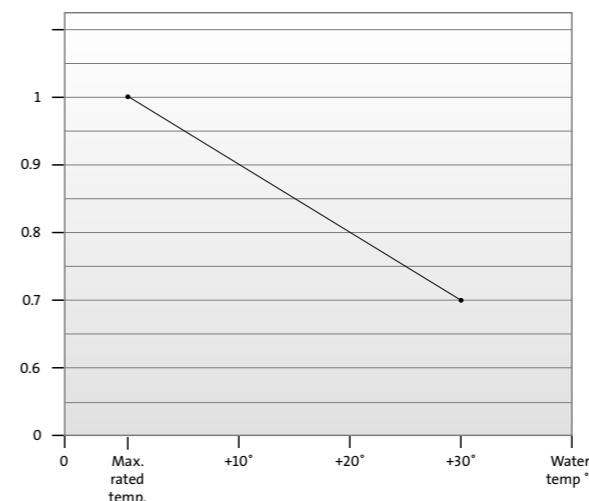

Fig. 57 Derating of submersible motors

Example:

A MS6T30 with standard rating, P2 = 30 kW, is able to produce $30 \times 0.9 = 27$ kW in 40 °C water at a cooling flow rate of 0.15 m/s. The submersible motor should be installed at the recommended depth.

Please note that derating of MS 4000I and MS6T60 is not recommended.

7.3.7 Protection against boiling

In order to protect the motor against boiling at pump stop and consequently a cooling water stop, it should be installed 5m below the dynamic water level. This will raise the boiling point.

Installation depth

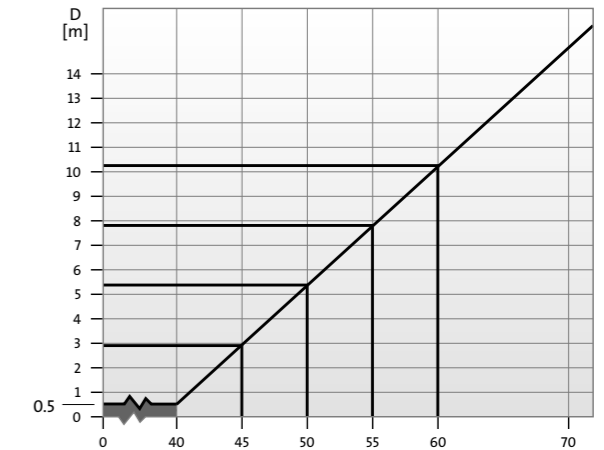

Fig. 58 Required water temperature/installation depth of MS 4000 and MS 6000

For MS 4000 and MS6, the best and simplest protection against overload and excessive temperatures is to measure the motor temperature by means of an MP 204. For other submersible motors, a Pt100/Pt1000 may be used to monitor the temperature.

7.3.8 Sleeve cooling

Flow past the motor must be a minimum of 0.15 m/s in order to secure proper cooling of the motor.

If the minimum flow past the motor cannot be obtained the natural way, Grundfos offers a range of cooling sleeves that ensure correct flow and cooling, and are easy to work with. Flow sleeves are typically used when the pump is installed in a reservoir or tank, or in a well, where the water flows to the pump from above, and therefore does not cool the motor. There must be reasonable spacing between the casing and the outer diameter to limit the pressure drop.

The recommended min. spacing between casing and flow sleeve may be calculated from the formula below:

$$v = \frac{Q \times 354}{(D^2 - d^2)}$$

v = m/s. Must be max. 3 m/s to limit head loss

Q = m³/h

D = Casing inner diameter in mm

d = Flow sleeve outer diameter in mm.

1. If the well water contains large amounts of iron (and iron bacteria), manganese and lime, these substances will be oxidised and deposited on the motor surface. This is approx. 5-15°C warmer than the influx water. In case of slow flow past the motor, this build-up of a heat insulating layer of oxidized minerals and metals may result in hot spots in the motor winding insulation. This temperature increase may reach values which will reduce the insulating ability and consequently the motor life. A cooling sleeve always gives a turbulent flow past the motor. Turbulent flow gives optimum cooling irrespective of the character of the deposits.
2. If the groundwater is aggressive or contains chloride, the corrosion rate will double for every 15°C increase in water temperature. A cooling sleeve will therefore reduce the risk of motor corrosion.
3. At the top of the well, oxidised raw water is found. Each time the pump starts, the water level in the well is lowered. This draws new oxygen into the well. This oxidation of the top few meters is harmless unless the oxygen reaches the screen. If the influx of raw water through the screen with a low content of oxygen is mixed with water containing fresh oxygen, iron, manganese and lime will oxidize and be deposited in the screen slots. This will reduce the efficiency and consequently the capacity of the well. A warm submersible motor without cooling sleeve will heat up the surrounding water when switched off.

The thermal effect will make the heated water move towards the top of the well. At the same time,

oxidized water will move towards the screen setting. When using a cooling sleeve, the motor will run at a lower temperature and when the motor stops, the cooling sleeve will absorb the residual heat from the motor and consequently prevent water from moving upward because of the thermal effect and oxidated water from moving downward. This will contribute to longer periods between well scalings.

For these applications, the risk of local heating should be considered, particularly in connection with horizontal installations and where several pumps are installed next to each other. In such cases, cooling sleeves should always be used.

7.4 Riser pipe selection

The choice of riser main depends on several different factors:

- Discharge pressure and installation depth
- The aggressivity of the groundwater
- Friction loss / operating cost
- Accessibility and cost of alternative
- Priority of initial costs in relation to service and repair costs at a later stage.

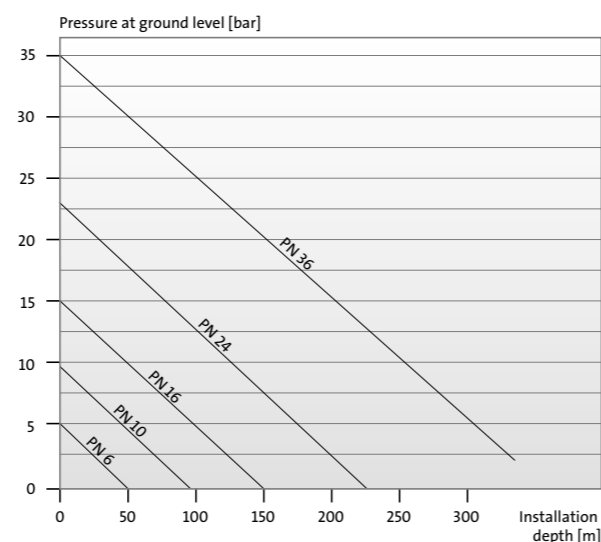

Fig. 59 Required pipe pressure class at different installation depths and actual pressure at ground level

The aggressivity of most groundwater is so moderate that coated or galvanized steel pipes will be fully acceptable.

PEL or PEM riser mains are primarily used for domestic applications. In case of water which is so aggressive that it will attack even the best stainless steel, replaceable zinc anodes should be fitted in order to protect motor and pump. In such installations, it will be too expensive to protect stainless steel riser mains against corrosion.

In such cases the Wellmaster is recommended. See chapter 10.

Friction loss in riser mains

Friction loss in pipes or hoses contributes significantly to the power consumption of a submersible pump. A small diameter steel pipe is cost-wise attractive, but it creates a lot of internal friction, and over time this is going to increase. The result is higher power consumption and costs.

A larger diameter stainless steel pipe represents a larger investment, but the lower friction loss requires less energy for pumping. The smooth internal surface is retained easier, requiring less maintenance for cleaning.

Example:

Flow is 54 m³/h, or 15 l/s.

Friction loss in 100m of 3" pipe and 100m of 4" pipe is calculated from a friction loss table.

3" pipe: 14 m

4" pipe: 3.8 m

Choosing a 4" pipe instead of a 3" pipe saves more than 10 m head per 100 m of pipe.

The energy savings are calculated as follows:

$$kWh = \frac{Q \times H}{367 \times \eta} = \frac{54 \times 10.2}{367 \times 0.6} = 2.45 kWh$$

Flexible hoses specially designed for pressurised water, like Wellmaster, are an alternative to stainless steel pipes. Some types are even approved for use with potable water.

This solution is generally recommended as a riser pipe for submersible pumps. Because of the hose design, the diameter will swell slightly when the hose is pressurised, and thus decrease friction loss. At the same time, it also prevents the built up of scaling on the surface, where the constant change of the diameter forces the scaling to break off.

The hose solution also makes pump pulling faster compared with the traditional piping solution, and is therefore also recommended when frequent pulling for service has to be done.

Never use fire hoses, nylon hoses or the like which age quickly, and do not have the required pressure rating. There is a risk that pump and motor will fall down into the well which may require the drilling of a new well. Remember to attach a wire to all hose installations to prevent the pump from falling into the well.

The disadvantage of flexible hose solutions is that sometimes it is difficult to prevent the hoses from getting into contact with the ground. This can cause contamination from bacteria and germs, which cannot be removed unless you employ expensive special equipment. When dimensioning riser mains and raw-water pipes by means of diagrams or PC programmes, remember to use a pipe surface roughness of 1 mm.

7.5 Cable selection and sizing

The drop cable is the cable running from the well head to the motor cable that is attached to the submersible motor.

Normally, the drop cable has four wires, where one is a ground/PE wire. In some local areas, a ground/PE is not required. Always check local regulation about grounding before cable type is selected.

Other criteria for drop cable selection are:

1. Current carrying capacity
2. Voltage drop
3. Water quality and temperature
4. Drinking water approval requirements
5. Regulations

Current-carrying capacity

Submersible pump drop cable is never dimensioned for the locked-rotor current, as the motor starts up in less than 1/10 of a second. Always use the full load current from the nameplate as the dimensioning current. The entire length of the drop cable is not submerged in water, so additional cooling from the water may be encountered.

Typical guidelines for max. amps in submersible drop cables:

Dimension (mm ²)	Max. current (A)
1.5	18.5
2.5	25
4	34
6	43
10	60
16	80
25	101
35	126
50	153
70	196
95	238
120	276
150	319
185	364
240	430
300	497

Please always check the local guidelines, which overrule the table above.

Voltage drop

The cable must be sized so the voltage drop does not exceed 3%. Under no circumstances must the voltage at the motor terminals be lower than the minimum voltage for the motor, which is the rated voltage minus 10%.

The maximum length is calculated according to the formulas shown below:

Max. cable length of a single-phase submersible pump:

$$L = \frac{U \times \Delta U}{I \times 2 \times 100 \times (\cos\phi \times \frac{\rho}{q} + \sin\phi \times XI)} \text{ [m]}$$

Max. cable length of a three-phase submersible pump:

$$L = \frac{U \times \Delta U}{I \times 1,73 \times 100 \times (\cos\phi \times \frac{\rho}{q} + \sin\phi \times XI)} \text{ [m]}$$

U = Rated voltage [V]

U = Voltage drop [%]

I = Rated current of the motor [A]

ρ = Specific resistance: 0.02 [mm²/m]

q = Cross-section of submersible drop cable [mm²]

XI = Inductive resistance: 0.078 x 10⁻³ [Ω/m]

Water quality and temperature

The best cable material for clean water is EPR (EPM or EPDM). This material has good electric properties combined with a good resistance to water. This type of cable is always recommended when the pumped water is not contaminated with hydrocarbons. EPR offers only limited resistance to hydrocarbons, however.

In lighter hydrocarbon solutions, a Chloroprene cable may be used.

In heavier concentrations of hydrocarbons it may be necessary to use PTFE (Teflon) jacketed cable. The SPE version of the SP pumps comes standard with PTFE motor cable, and makes it suitable for pumping water with a high content of hydrocarbons.

A lower cost solution is a standard Chloroprene type of cable. Specifications may be obtained from Grundfos.

When the water temperature increases, the cable must be derated. The current carrying capacity of the drop cables is usually valid at 30°C. At higher temperatures, this must always be compensated in accordance with the table below.

Cable type	TML-A-B	H07RN
Insulation material	EPR	NR/SR
Ambient temp. °C	Correction factor	Correction factor
10	1.18	1.29
15	1.14	1.22
20	1.10	1.15
25	1.05	1.05
30	1.00	1.00
35	0.95	0.91
40	0.89	0.82
45	0.84	0.71
50	0.77	0.58
55	0.71	0.41
60	0.63	-
65	0.55	-
70	0.45	-

Drinking water approval

All Grundfos motors outside North America and Japan are delivered from factory with drinking water-approved motor cables. If the pump is used for pumping potable water, Grundfos always recommends also using a drop cable that has a drinking water approval.

Regulations

Local regulations must always be checked and followed.

7.6 Handling

7.6.1 Pump / motor assembly

Grundfos submersible pumps and motors are all made in accordance with NEMA standards. They are fully compatible with pumps and motors that conform to these standards as well. Grundfos recommends always using only a Grundfos pump together with a Grundfos motor and vice versa.

For detailed assembly instructions please see the individual installation and operating instructions for SP pumps.

7.6.2 Cable splice/connection of motor cable and drop cable

Faulty or unapproved cable joints are frequent causes of burned-out motors. Grundfos-recommended products or products of similar quality should be chosen and the manufacturer's guidelines followed. Any cable joint must be watertight and have an insulation resistance of minimum 10 megaohms, measured in a submerged state after 24 hours in water. In order to obtain this, all cable parts must be 100% clean and all other requirements indicated in the service manual and in service video programmes observed. There are four ways of making a cable joint.

1. Heat shrink

Heat shrink is a plastic tube with the inside covered with glue. When exposed to heat, it will shrink, and the glue melts, and makes a watertight cable splice. It takes a lot of practice to perform this kind of joint. Furthermore, high temperature are required for large cable types. Lighters and hobby heaters are not sufficient. The advantage of this principle is that the connection does not require time for drying but is ready immediately after fitting.

2. Resin

Sealing with resin is the oldest and best known type of joint. It is also the joint which is simplest to carry out correctly. It can be performed in the field without special tools. The disadvantage is that it must harden for at least 24 hours. As far as the price is concerned, there is no difference between this and shrink flex.

3. Tape

It is important to use special tape for connecting submersible cables. Tape joints should only be used at water pressures below 5 m.

4. Plug connection

It is important not to use cable joint kits or tape which are more than three years old. This age limit should be reduced to one year if stored above 15°C. Always test the cable joint during maintenance.

Motor cable plug

The motor cable plug must always be fitted at the torque stated in the documentation. In case of lu-

brication of the cable plug, a non-conductive material should be used (e.g. silicone paste). Motor cable plugs that are more than three years old should not be reused, as they may have lost the ability to make a safe, water tight connection.

7.6.3 Riser pipe connections

Submersible pumps are available both with RP and NPT threads, as well as flanges in various standards.

In general, however, Grundfos recommends fitting a 50 cm length of pipe first to the pump. This gives good handling of the pump during the installation, as the pump does not become too long. It also leaves room for the clamp which holds the pump until the next pipe has been fitted.

As an alternative to a threaded connection, various flange types can be offered: Grundfos flanges, JIS flanges and DIN flanges.

Pipe connections and installation

Grundfos standard flanges are made particularly for fitting into a well. This means that they do not comply with any national nor international standards; they have been dimensioned to withstand Grundfos pump pressures.

There are several advantages in using Grundfos standard flanges instead of other flanges. They are not only cheaper, and because of their dimension they are easier to fit into the well.

Grundfos can supply counter flanges for Grundfos flanges, which can be welded onto the first pipe.

7.7 Pumps in parallel operation

Parallel pumping operation is often used with a variable consumption pattern. A single pump operation would require a high capacity pump, where the spare capacity is only used in a very short period. The investment would be very high, and the operational efficiency too low. The peaks may also result in additional drawdown of the dynamic water level with a number of water- and well quality issues as a result.

These problems are typically avoided by using one of the following:

1. Several smaller cascade operated pumps (additional pumps starts and stops as demand changes)
2. Frequency control of the pump via a pressure transducer
3. A combination of 1 and 2.

For correct pump selection, the well's characteristics must be known, either from the well log or a test pumping.

7.8 Pumps in series operation

With pump setting deeper than the max. head capacity of a standard SP pump, it may be coupled in series with a BM pump (SP in sleeve). See fig. 60.

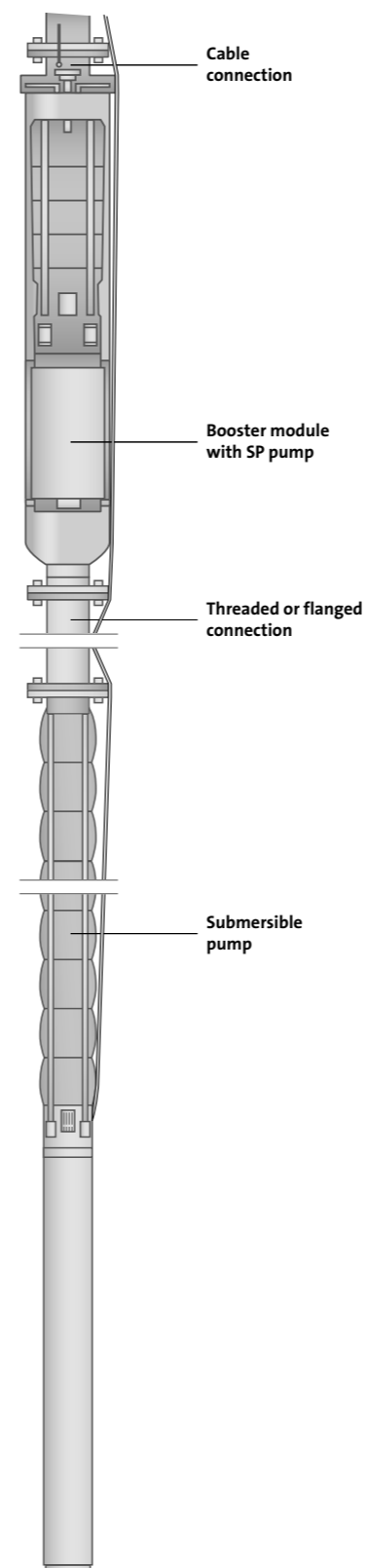

Fig. 60 Series coupled submersible pump

7.9 Number of start/stops

In order to get a maximum life out of the submersible pumps, the number of starts must be limited. It is usually the motor that is the limiting factor. It is also necessary to start the motor at least once per year to avoid it from seizing up.

The table below shows the recommended max. number of starts for different motor types:

Incl. N, R and RE versions	Min. starts per year	Max. starts per hour	Max. starts per day
MS 402	1	100	300
MS 4000	1	100	300
MS6/MS 6000	1	30	300
MMS 6000	1	15	360
MMS 8000	1	10	240
MMS 10000	1	8	190
MMS 12000	1	5	120

7.10 Pump start-up

Detailed information about methods for reducing locked-rotor current, see chapter 5.

You should always follow the instructions found in the installation and operating instructions for each pump regarding start up.

For pumps in series connections, remember to start them in the correct sequence: the pump with the lowest ambient pressure must be started first.

For pumps in parallel operation, remember that air venting possibilities are already built into the system. This will prevent air locking.

7.11 VFD operation

See chapter 5.

7.12 Generator operation

Engine driven generators for submersible motors are often offered according to standard conditions, e.g.

- Max. altitude above sea level: 150 m
- Max. air inlet temperature: 30 °C
- Max. humidity: 60%.

If these limits are exceeded, the standard diesel engine and possibly the generator have to be derated in order to give the motor sufficient power supply.

When ordering a generator set, altitude, air inlet temperature and maximum humidity should be given to the manufacturer to have the generator factory derated. Generator sets for three-phase submersible motors must be able to withstand 35% voltage reduction during start-up.

For the selection of internally regulated generators available, stick to the tables below for continuous break kW for single-phase and three-phase motors with DOL start.

Examples of derating factors for standard diesel engines	Examples of derating factors for standard generators
Altitude: 3.5% for every 300 m above 150 m above sea level (2.5% for turbo-charged engines).	Altitude: 2.5% for every 300 m above 1000 m above sea level.
Air inlet temperature: 2% for every 5.5 °C above 30 °C (3% for turbo-charged engines).	Air inlet temperature: 5% for every 5 °C above 40 °C.
Humidity: 6% at 100% humidity.	

Submersible motor rating for single-phase and three-phase versions [kW]	Generator rating		Elevation of max. 150 m and a humidity of 100%		Elevation of max. 750 m and a humidity of 100%	
			Diesel engine rating at an ambient temperature of			
	[kW]	[kW]	30 °C [kW]	40 °C [kW]	30 °C [kW]	40 °C [kW]
0.25	1.5	1.0	1.25	1.3	1.4	1.43
0.37	2.0	1.5	2.0	2.1	2.3	2.3
0.55	2.5	2.0	2.5	3.1	2.8	2.86
0.75	3.0	2.5	3.0	3.1	3.4	3.44
1.1	4.0	3.0	4.0	4.2	4.5	4.58
1.5	5.0	4.0	5.0	5.2	5.6	5.73
2.2	7.0	6.0	7.0	7.3	7.8	8.0
3.7	11.0	9.0	10.0	10.4	11.1	11.5
5.5	16.0	12.5	14.0	14.6	15.6	16.0
7.5	19.0	15.0	17.0	17.7	19.0	20.0
11.0	28.0	22.0	25.0	26.0	28.0	29.0
15.0	38.0	30.0	35.0	36.0	39.0	40.0
18.5	50.0	40.0	45.0	47.0	50.0	52.0
22.0	55.0	45.0	50.0	52.0	56.0	57.0
30.0	75.0	60.0	65.0	68.0	72.0	75.0
37.0	95.0	75.0	83.0	86.0	92.0	95.0
45.0	110.0	90.0	100.0	104.0	111.0	115.0
55.0	135.0	110.0	120.0	125.0	133.0	137.0
75.0	185.0	150.0	165.0	172.0	183.0	189.0
90.0	220.0	175.0	192.5	200.0	215.0	220.0
110.0	250.0	200.0	220.0	230.0	244.0	250.0
132.0	313.0	250.0	275.0	290.0	305.0	315.0
150.0	344.0	275.0	305.0	315.0	335.0	345.0
185.0	396.0	330.0	365.0	405.0	405.0	415.0

If the generator and diesel engine are derated according to the table, the following criteria apply:

1. The voltage drop at the generator will not exceed 10% during start-up. This means that it is possible to use even the fastest undervoltage protection on the market in the starter box of the pump motor.
2. Generator and diesel engine will have a normal life as the new fully run-in engine is only loaded approx. 70% with continuous pump motor rated current. A diesel engine will typically have maximum efficiency (lowest fuel consumption per kW output) at 70-80% of maximum load.

3. By autotransformer start or installation of a Grundfos MP 204 for undervoltage protection, it is possible to choose both a generator and diesel engine than are 20% smaller than stated in the table. This, however, means frequent maintenance of air filter and injection nozzles, cleaning of the cooler and change of oil. Furthermore, it will result in a voltage drop during start-up of up to 20%. If the loss in the drop cable and motor cable of up to 15% is added, the total voltage loss will be more than 35% at the motor. This is no problem for three-phase motors, but sometimes for single-phase motors, which will often require an oversize starting capacitor for low start-up voltages.

There are two types of generators: internally and externally-regulated.

Internally-regulated generators have an additional winding in the generator stator and are also called self-excited. The extra winding senses the output current and increases the output voltage automatically.

Internally-regulated generators normally show the best running efficiency.

Externally-regulated generators use an externally mounted voltage regulator that senses the output voltage. As the voltage dips at motor start-up, the regulator increases the output voltage of the generator.

An externally-regulated generator is to be dimensioned approximately 50% higher in kW/kVA rating to deliver the same starting torque as an internally regulated generator.

Generator frequency is all important as the motor speed varies with the frequency [Hz]. Due to pump affinity laws, a pump running at 1 to 2 Hz below motor nameplate frequency will not meet its performance curve. Conversely, a pump running 1 or 2 Hz higher may trip the overload relay.

Generator operation

Always start the generator before the motor is started and always stop the motor before the generator is stopped. The motor thrust bearing may be damaged if generators are allowed to coast down with the motor connected. The same condition occurs when generators are allowed to run out of fuel.

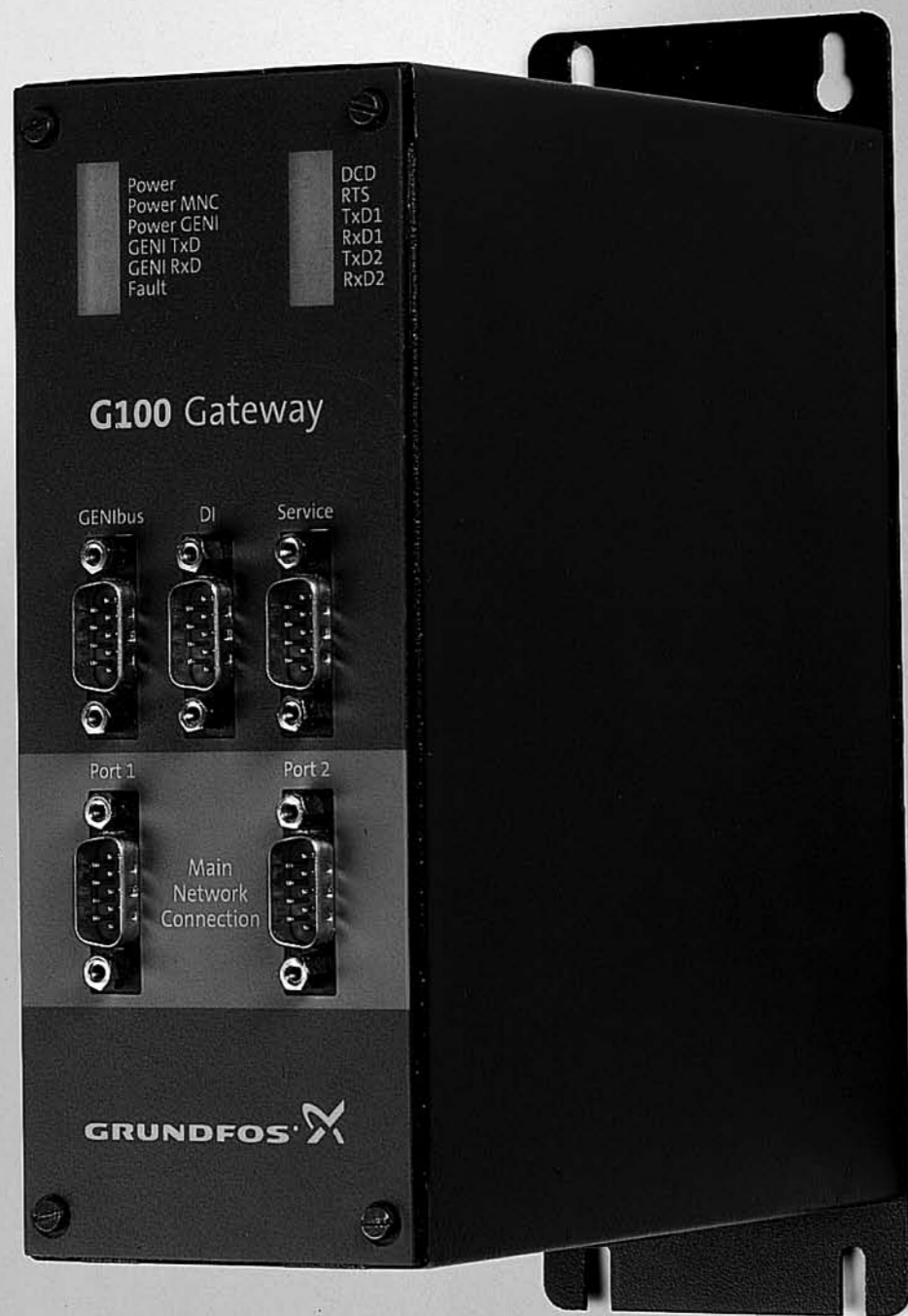

8. Communication

8.1 Purpose of communication and networking

There are two main purposes of using data communication and networking in relation to equipment and machinery in all industrial installations or in processing installations like water supply plants:

To centralise supervision and control

It is well documented that most automation systems can benefit substantially from centralisation of control and supervision. The issues that are most often mentioned are:

- Optimise performance (e.g. energy and material savings)
- Optimise process quality (corrective actions)
- Better maintenance (service on demand)
- Reduction of running costs (e.g. staff cutting)
- Organised/quick reaction to faults (minimise down time)
- Easy access to current data and the possibility to store data in data bases (report generation)

Systems for this kind of central management are called *SCADA systems* (Supervisory Control and Data Acquisition)

To realise distributed systems

Many of today's automation systems would never be realisable without data communication. In an automation system, discreet devices, which are physically separated, have to exchange data. These are typically in the form of measured physical values, commands and set points.

The discreet devices work together to fulfil a superior purpose (e.g. supplying water) and by doing so they constitute what is called a *distributed system*. Each device is like a component in a larger entity, contributing to the overall performance, efficiency and reliability of the system.

The number of discreet devices can often be very huge and so can the distance between them. In these cases the communication and networking in itself becomes the most important and vulnerable part of the system and its ability to fulfil its purpose.

It is important that the selection of network and communications protocol is not a limiting factor for

the system performance and especially that it is not a limiting factor for the future growth and flexibility.

8.2 Communications and networking technology

The use of communication and networking is inevitable in modern automation systems, but the kind of system and the used technology is very diversified. Systems made before 1995 were almost always based on electrical cables, whereas the technology today offer fiber optics or radio communication as an alternative (or combined) solution.

Optical fibers are flexible and can be bundled as cables. It is especially advantageous for long-distance communications, because light propagates through the fiber with little attenuation compared to electrical cables. Additionally, the light signals propagating in the fiber can be modulated at rates as high as 40 Gb/s, and each fiber can carry many independent channels, each by a different wavelength of light. Fiber is also immune to electrical interference, which also means immunity to damaging voltage surges induced by lightning – a big advantage when using long-distance cabling in outdoor installations.

Communication using radio signals falls in two categories: Short distance and long distance radio communication. We know the technology of short distance radio communication from wireless LANs. Most fieldbusses offer wireless repeaters to extend the fieldbus communication distance over relatively short ranges or to avoid using cables where cabling would be costly or impractical (e.g. moving devices).

Long distance radio communication can be based on private radio telemetry. The UHF band between 400 MHz to 500MHz has become internationally adopted for low power license-free use for digital data and telemetry systems. It has the advantage of propagating in direct line of sight and will penetrate conventional building materials. For distances above 1000 m, radios with higher power requiring a licensed channel is typically needed.

For radio communication in areas that are covered by existing *operator networks* like GSM the easiest (but not always the cheapest) way of establishing remote communication is by subscription to this service. It is up to the customer (or the system integrator he is using) to examine and assess if the demands for communication speed, response time and reliability are fulfilled.

In recent years Ethernet networking technology, with the communications protocol TCP/IP, which has traditionally been used for LANs and which has become totally dominating within that field, has started to migrate to fieldbus applications. Here it now enters into competition with the traditional fieldbuses like DeviceNet, Profibus, Modbus, etc., but instead of representing one coherent protocol, Ethernet TCP/IP shows up in many incompatible standards like Ethernet IP (a DeviceNet variant), Profinet (a Profibus variant), Modbus TCP (a Modbus variant) and similar standards that are based on (and compatible with) corresponding old fieldbuses. The fact that some new Ethernet standards like EtherCat that are specially designed to utilize the high speed advantages of Ethernet have also emerged has not made the choice and compatibility situation within networking of automation systems easier.

8.3 SCADA systems

8.3.1 SCADA main parts

The three main parts of a typical SCADA system are:

1. A master computer

The computer (e.g. a PC running Windows or Unix) has HMI (Human Machine Interface) software and a database. Numerous specialized third party HMI/SCADA software packages are available. Some examples are iFix from GE Fanuc, CitectSCADA from Citect, SIMATIC from Siemens and Wonderware from Inven-sys.

2. A number of outstations

An outstation often represents an *autonomous* subsystem. Autonomous means that if the connection to

the SCADA system is broken, the subsystem is able to keep on operating alone and still fulfilling its purpose (e.g. supplying water to a tank). The overall system design (choice of technology and equipment) should aim at subsystem autonomy whenever possible and always without exception ensure that subsystems are failsafe and will return to a predictable well-defined and secure state if communication with SCADA is broken. The outstation will typically be:

- A PLC (Programmable Logic Controller)
- A DDC (Dedicated Digital Controller)
- A gateway to another (underlying) network

3. A communications infrastructure

This is what ties it all together. A mix of technologies will often be used as no single technology (network or protocol) spans all demands in more complex applications.

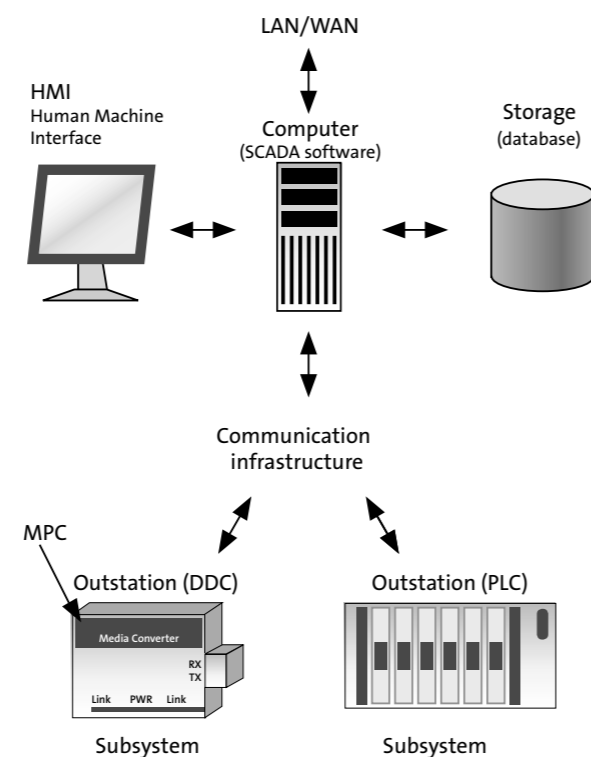

Fig. 61 Illustration of the main parts of a SCADA system

8.3.2 SCADA functions

Below is a list of the functions that is typically found in SCADA system software packages. The list is prioritized with the most important functions at the top.

SCADA system software often has network server capability, meaning that if the host PC is connected to a LAN or to the internet, it will be possible to log on to the system remotely from another network connected PC. The SCADA system software is a standard package (available from many different software vendors), but with a high degree of customized adaptation (data, functions, graphics, etc).

1. Establish the health of the system
 - Is system OK (operating as intended and fulfilling its purpose)?
 - Does the system need service (cause and kind)?
 - Is the system broken down (cause)?
2. Display system variables/conditions
 - Conditions (like on/off) illustrated with graphics and colors
 - Important system variables displayed on system drawing (pressure, flow, etc.)
 - Important system variables shown graphically
3. Alarm logging and alarm routing
 - Managing duty rosters
 - Routing of messages (e.g. SMS)
4. Data logging / Retrieval of logged data
 - Interface to database (e.g. Microsoft SQL)
 - Data processing / Data storing / Graphical visualization
5. Control
 - Manually operation
 - Automatic operation
 - Closed loop control (rare)
6. Setup
 - Display main setup parameters
 - Changing of main setup parameters
7. Maintenance information
 - Maintenance plan and history
 - Spare parts list
 - Manuals, photos, instructive videos
8. Expert system
 - Artificial intelligence
 - Fault diagnostics
 - Decision support
9. Interfacing to Enterprise Resource Planning (ERP).

8.3.3 Web-hosted SCADA

A SCADA system software which runs on a web server instead of on a normal Windows PC is called a *web-*

hosted SCADA system. All data is accessible via the internet by the use of a web-browser (e.g. Internet Explorer).

The subsystems can be monitored and operated from any PC in any location with internet access all over the world. There is no need to install an expensive software system on one or more PC.

The SCADA system software and all the data resides on the web server, which could be operated by a contractor (system integrator) or by the customer (e.g. a central web server for a complete municipality).

The customer/user doesn't have to worry about information, communication and software/hardware technology but can concentrate on the practical use of the data and the practical maintenance of the subsystem.

Passwords ensure that only authorised personnel receives access to operate specific subsystems.

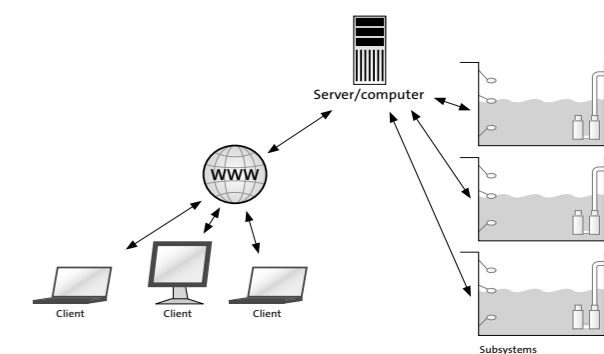

Fig. 62 Illustration of the principle in web-hosted SCADA

8.4 Networking basics

8.4.1 Network topology

Refers to the way in which the network of communicating devices is connected. Each topology is suited to specific tasks and has its own advantages and disadvantages.

In a *star network*, all wiring is done from a central point (e.g. a hub or a central controller). It has the greatest cable lengths of any topology and thus uses the most amount of cable. Ethernet networks are usually based on the star topology.

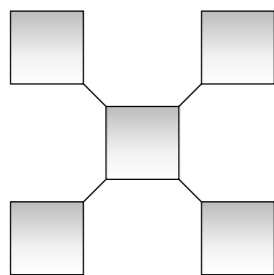

Fig. 63 Star topology

Advantages	Disadvantages
<ul style="list-style-type: none"> • Easy to add new devices • Centralized control, network/hub monitoring 	<ul style="list-style-type: none"> • Hub failure cripples all devices connected to that hub

A *ring network*, is a network topology in which each network device connects to exactly two other devices, forming a circular pathway for signals. Data travels from device to device, with each device handling every packet. The old IBM LAN standard Token Ring and the industrial fieldbus Interbus are both using the ring topology.

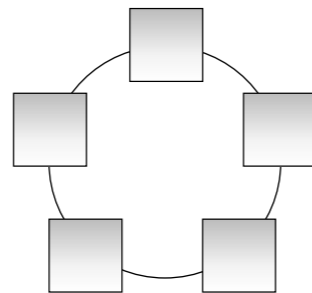

Fig. 64 Ring topology

Advantages	Disadvantages
<ul style="list-style-type: none"> • Equal access for all devices • Each device has full access speed to the ring • Only slight performance drop with increased no. of devices. 	<ul style="list-style-type: none"> • Costly wiring • Difficult and expensive connections

In a *bus network*, all devices connect to the same cable segment. Wiring is normally done point to point in a chain fashion or via drop cables. The cable is terminated at each end. Messages transmitted along the cable are visible to all devices connected to that cable. Most fieldbuses (e.g. Profibus, DeviceNet, GENIbus) use the bus topology, but despite the name, fieldbuses can also be based on other topologies.

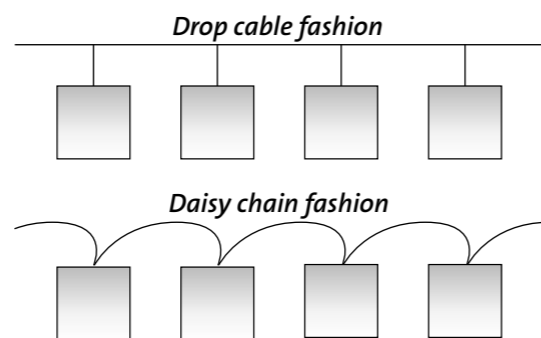

Fig. 65 Bus topology

Advantages	Disadvantages
<ul style="list-style-type: none"> • Easy to implement • Low cost 	<ul style="list-style-type: none"> • Limits on cable length and device numbers • Difficult to isolate network faults • A cable fault affects all devices • Network slows down with increased no. of devices

Very often a combination of these three basic topologies is used – then we talk about *mixed topology*. If the networking technology used allows connection in any topology – then we talk about *free topology*.

8.4.2 Communications protocol

The *communications protocol* covers the rules that specify how a functional device connected to a network can interchange data with other devices that are part of the network. It specifies details in the physical hardware like impedance and electrical signals. It specifies details in the data transfer like baud rate, timing and data packet format and it specifies how addressing of devices, requesting of data and replying to requests should work.

The communications protocol is the manager of the communication line. The protocol rules control who is allowed to transmit, how much and for how long. In master/slave protocols (like GENIbus, Modbus, Profibus) the arbitration rules of the protocol control who is master and who is slave.

It is the responsibility of the protocol that everything works reliably and that data gets communicated without errors. But in cases where something goes wrong, in protocol terms called *exceptions*, it is also the responsibility of the protocol to detect these exceptions, to react upon them (e.g. error reporting, retransmission, etc.) and finally to recover from any error condition including from a complete network break down.

8.4.3 Functional profile

The *functional profile* of a network device means the specification of its functional interface to the network. This is primarily a description of the input and the output data of the device. These data are most often referred to as the data points or the data items of the device. The functional profile describes the data items – what format they have (8 bit, 16 bit, etc.), their scaling (resolution and range), limitations and mutual relation.

Apart from the data item description, the functional profile also describes how to operate the device via

the network, when the device is used in applications. It documents the relation between the device functions, the data items and the behaviour of the application/system in which the device is operating.

Devices that use the same communications protocol and exchange data according to a defined and shared functional profile are said to be *interoperable*.

8.4.4 The fieldbus

The kind of networks that are used in industrial automation systems to connect sensors, actuator and controllers are called *fieldbuses* as opposed to networks used for administrative purposes in office environments, which are generally referred to as *Local Area Networks (LANs)*.

Fieldbuses are designed to work in harsh environments – out in the field so to speak - and use industrial grade equipment and cabling. Moreover a fieldbus protocol generally promotes other characteristics than a LAN does, because the demands are quite different.

The fieldbus typically transfers small amounts of data, but the data is transferred frequently (high sample rates can often be a requirement). Also the fieldbus must be able to handle time critical data transfer, meaning it has to fulfil hard timing requirements (low delays in bus access and data reply and fast data processing).

The LAN, on the other hand, transfers huge amounts of data (files, etc.) between computers and servers, but these data are transferred seldom. Also the reaction need not be very fast, because it interacts with humans and not with time-critical physical processes.

8.5. GENIbus

GENIbus, the Grundfos Electronics Network Intercommunications bus is a proprietary fieldbus developed by Grundfos to meet the need for data transfer and networking in typical water pump applications in buildings, water supply, water purification and industry.

8.5.1 Background

GENIbus was first introduced to the market in 1991 as a fieldbus interface for the Grundfos circulator pump type UPE. This pump became the first water pump in the world with integrated frequency converter and also the first with integrated fieldbus interface.

The original purpose of the GENIbus interface was to enable networking of the speed controlled circulator pumps into subsystems, where a central master could handle several control loops with pumps connected hydraulically parallel and at the same time make important pump data like pressure, flow and alarms available on a display.

Since then GENIbus has developed into an advanced and yet cost effective de-facto Grundfos standard and is available for almost all Grundfos products with electronics. Its main area of application is:

- Networking between pumps, auxiliary devices and controllers in Grundfos subsystems (e.g. Hydro MPC)
- Integration in automation systems (e.g. SCADA) via gateways
- Connection to PC tools via adapter for configuration, faultfinding, value monitoring, data logging, etc.

8.5.2 Technical description

Like most other fieldbuses, GENIbus supports the mechanisms for single-casting (single-addressing), multicasting (group addressing) and broadcasting (global addressing). A unique feature of GENIbus is the *Connection Request*, which makes it possible for a master device to recognize all connected units on a network without having to poll through all possible addresses.

Having been developed and now being maintained by a single company instead of by an independent user organization makes GENIbus a so-called *proprietary fieldbus*. However the standard is open for anyone to use, which has resulted in the emergence of several third party gateways enabling the connection of GENIbus devices (e.g. pumps) to controllers of other brands and of gateways, which can connect GENIbus to a few recognized fieldbus standards.

Below is a GENIbus technical summary. The complete GENIbus protocol specification is available on request.

Physical layer (hardware)	
Topology	Bus
Transmitter	EIA RS485, half duplex
Data format	Start bit (=0), 8 data bits with least significant bit first, stop bit (=1)
Baud rate	9600 bits/s Some devices support programmable baud rate from 1200-38400 bits/s
Distance	Daisy chain: 1200 m Multidrop: 500 m Twisted pair cable with shield is recommended. No termination.
No. of bus units	Max. 32

Data link layer (timing, verification)	
Inter Byte Delay	<=1.2ms
Inter Telegram Delay	>=3ms
Reply Delay	[3ms; 50ms] Some devices support programmable minimum reply delay [3ms; 2.5s]
Cyclic redundancy checking	16 bit CCITT
Medium access	Master/Slave
Physical address range	Master address range: [0; 231] Slave address range: [32; 231] Connection request address: 254 Broadcast address: 255

8.5.3 Cabling guidelines

In general

- Use twisted pair cables with shield
- Connect the shield in both ends
- Daisy chaining is the preferred way to connect multiple units
- Avoid long stubs
- Keep wires as short as possible
- Separate bus wires from power cables if possible.

GENIbus

- Do not use terminating resistors
- A communication distance up to 1200 m is normally not a problem
- The distance can be extended with repeaters
- If you experience problems with noise, try disconnecting the shield that is found at one end per bus unit.

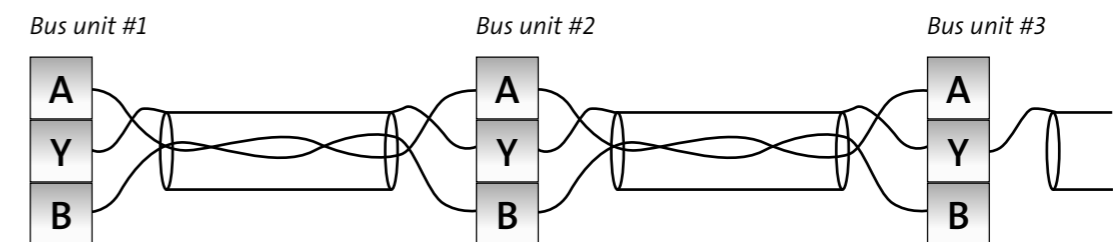
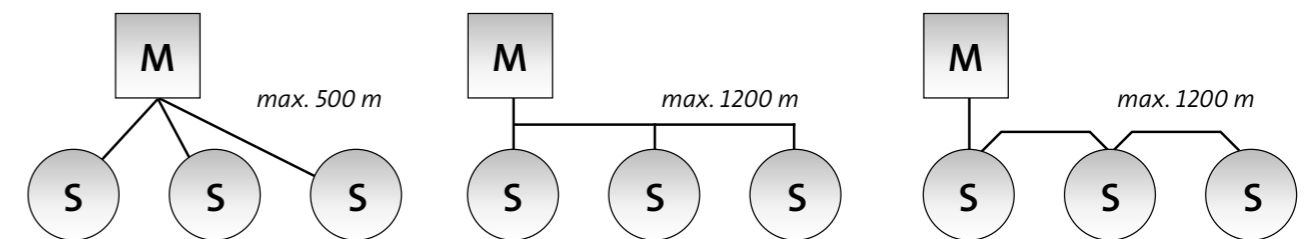

Daisy chaining, the ideal way of cabling GENIbus

8.6 Grundfos GENIbus products for SP applications

By the usage of the electronic motor protector MP 204 (described in chapter 10, "Accessories") it is possible to monitor the SP pump remotely:

- 3-phase current and voltages
- 3-phase voltage angles and $\cos(\theta)$
- Start current
- Current asymmetry
- Insulation resistance
- Power and energy consumption
- Supply frequency
- Motor temperature
- Present alarms and warnings
- Logged alarms
- Power on time and running time counter
- Start counter (total and per hour)
- Re-start counter (total and per day)
- Operating mode of MP 204 motor protector.

By operating the electronic motor protector MP 204 as an on/off actuator, it is possible to start/stop control the SP pump remotely. It is also possible to reset alarms, logged alarms and various counters like running hours and start counters.

By the usage of the input/output IO 111 device (described in chapter 10, "Accessories") alone or together with MP 204 it is possible to monitor the following values:

- Value of PT100 temperature sensor
- Value of pulse counter input
- Value of analogue 4-20mA input
- Alarm limit exceeded (for the above inputs)
- Power on time
- Logged alarms.

MP 204 and IO 112 both have GENIbus interface. MP 204 is supported by the Grundfos gateway G100 (data sheet available via WEBCaps), which can handle simultaneous connection of up to 32 MP 204 devices and supports communication via Modbus (RS232, radio or GSM) or via Profibus. It also has a built in data logger with a capacity of approximately 300,000 time stamped loggings.

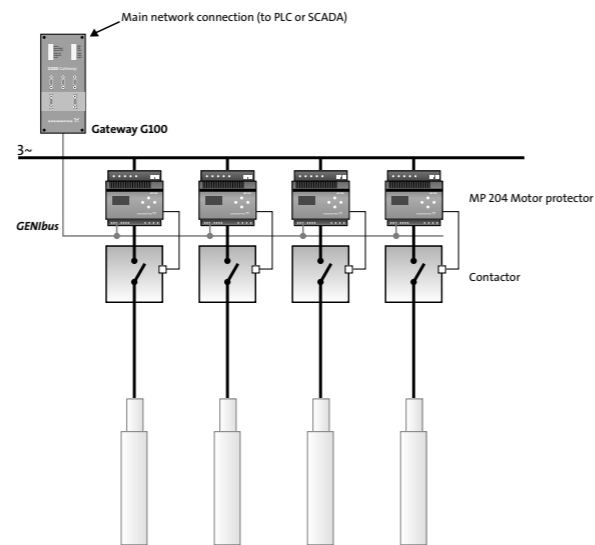

Fig. 66 Illustration of the remote monitoring and control of SP pump installations



9. Troubleshooting

Fault	Cause	Solution
Loud noises in pipework in home or building. Pressure gauges stop working after short time. Blow-out in piping and fittings	Water hammer at pump start and stop.	Fit a 50-litre diaphragm tank where the riser main and the horizontal discharge pipe meet. Water from this diaphragm tank will be discharged when the pump is switched off and thus prevent the formation of the vacuum.
Air penetrating suction piping as well as pressurised piping.	Water hammer creating vacuum	Introduce soft -start/stop,- VFD or pressure tank shock absorption.
A rapid decline in pump performance.	Wear and tear due to sand/silt penetrating into well	Detect the problematic wells, seal off the problematic section of the well or reduce pump performance to less than half of the problematic capacity.
Contactors fail too often, and motors consume excessive kWh per m ³ pumped.	High starting frequency	Reduce pump capacity, install a VFD or larger tank capacity.
Power consumption by the motor is excessive, and shaft /coupling splines wear down.	Upthrust	Throttle pump performance to around the best efficiency point or reduce the number of impellers on the pump.
Worn upthrust bearings	Upthrust by ON/OFF operation	Establish the necessary flow control at start-up.
Thrust bearings on canned type motors fail Insulation resistance on rewindable motors fails.	Cavitation	Remove flow restrictions to pump and check for performance around the best efficiency point.
Motor temperature increases over time; pump performance falls.	Deposits (Calcium, Iron, etc) on motor surface and in hydraulic parts of pump.	Pull the pump and motor for cleaning; clean the piping, well filter and install a cooling sleeve on motor.
Pump performance falls off	Aggressive water (Corrosion of pump and pipes)	Pressure test piping from ground level. If leakages occur, pull and replace the pump and pipes with a higher corrosion class.
Water disappears down the piping when the pump is stopped	Riser mains pipe corrosion	Pull the pump and replace the piping material with a higher corrosion class.
Pump performance is too low. The motor consumes insufficient kWh.	Gas evacuation	Lower the pump when equipped with gas evacuation sleeve.
The water level in the well is constantly becoming lower.	Well overpumping	Reduce pump capacity until the water level remains constant over the course of a year. Drill more wells at other aquifers.



10. Accessories

10.1 Cooling sleeves

In general, cooling sleeves are recommended when the motor cooling is insufficient. This is normal in tank applications. It can also be necessary in deep well applications, where there is a risk that the water will flow to the pump inlet from above and not automatically pass along the motor.

Other applications where a flow sleeve should be used:

- The motor is exposed to a high thermal load, such as due to a high ambient temperature, current unbalance or overload.
- Aggressive liquids are pumped, since corrosion is doubled for every 10 °C increase in temperature.
- Sedimentation or deposits occur around and/or on the motor.

By using the cooling sleeves, the flow along the motor will minimize the motor temperature and thereby extend the motor life.

10.2 Corrosion protection in seawater

Stainless steel can be damaged by crevice or pitting corrosion when immersed into chlorinated water.

The likelihood of corrosion depends on:

- The grade of material used (GG – AISI 304 – AISI 316 – AISI 904L)
- Chloride concentration in the water
- Electrochemical potential of the metal exposed to media
- Temperature
- Oxygen concentration
- Velocity of the media in contact with the metallic surface
- The pH value.

When metal is submerged into water, it forms an electrochemical cell, with an anode and a cathode immersed into an electrolyte (ex. chlorinated water). This is also referred to as being a galvanic cell. The anode can be referred to as the active part and the cathode as the noble part.

Metals can be listed in order to their relative activity in seawater environment. If the metal surface becomes the anode in the electrochemical cell, corrosion takes place.

10.2.1 Cathodic protection

Cathodic protection is a technique to control the corrosion of a given metal surface by purposely making this surface into the cathode of the electrochemical cell.

This can be done in two ways:

- Galvanic: by use of sacrificial metal
- Impressed Current: by use of DC power supply and an inert anode.

10.2.2 Galvanic cathodic protection systems

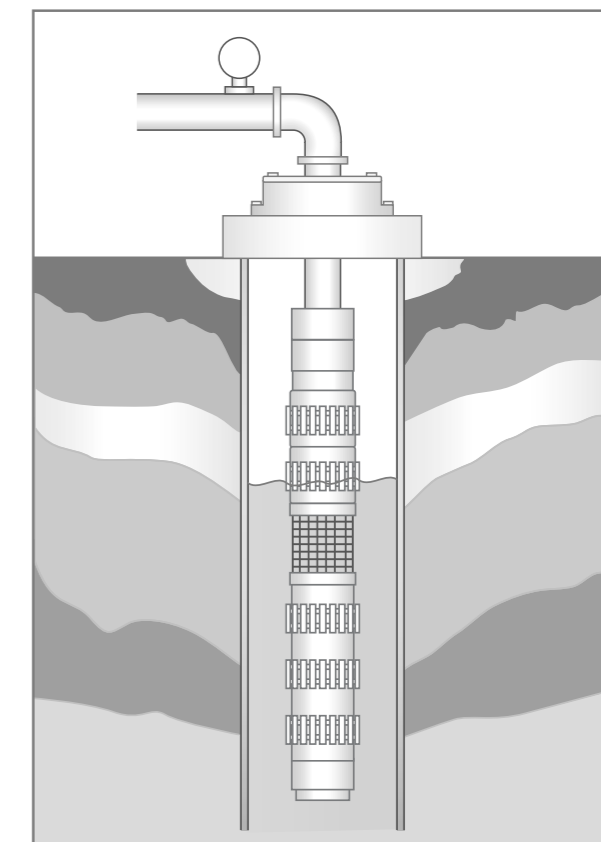

Fig. 67 Submersible pump set with sacrificial zinc anodes.

Grundfos offers a series of sacrificial zinc anodes for the submersible pump and motor. For metallic riser pipes, standard solutions for pipes are recommended.

The use of sacrificial anodes has an environmental impact that should always be taken into account. The effects of the salts being formed in the galvanic process must always be taken into account.

The system needs to be monitored in order to find the correct time for replacing the sacrificial anodes.

The advantage is that the system is self regulating – the deterioration of the sacrificial anode reflects the needs for protection of the system.

For bigger and more complex systems, engineering is needed in order to make the correct choice concerning corrosion protection. Aspects to consider include

- Material of sacrificial anode
- Shape
- Extension
- Connection.

10.2.3 Impressed current cathodic protection systems

This requires use of a DC power supply and knowledge of actual potential between the metal that needs protection and a reference electrode. It is necessary to take into account the risk of organic growth on the metal part that over time can change the potential difference.

These systems require individual design and Grundfos refers to external suppliers of these kinds of equipment where design and advices can be obtained. The normal range of the DC supply will be 50 V with 10-100 A.

The advantage of this method is that it is inert, meaning that it does not release any chemical agents to the environment. The process requires energy in the form of a power supply.

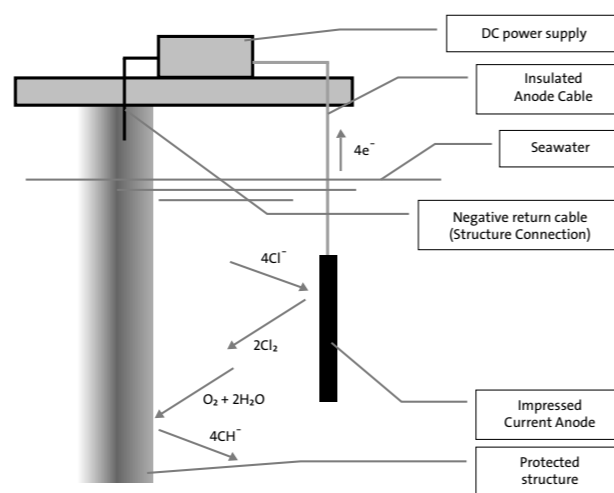

Fig. 68 Principle of impressed current cathodic system

10.3 Drop cables

Grundfos can deliver different drop cable types depending on the application the pump is going to operate in. General guidelines have been described in chapter 7.5.

There are cables specially developed to be used in connection with submersible pumps. Several of them are approved for transporting drinking water. Numerous manufacturers produce these cables which may be used with submersible pumps.

A commonly used type is the H07RN-F, which is a general purpose cable. In most cases this cable is adequate for use with submersible pumps. Please note that water resistance of the conductor insulation is not always good enough.

Grundfos always recommends having the cable manufacturer guarantee that the cable can fulfil Grundfos standard GS418A0010, which is an additional insulation resistance test with the cable submerged in water.

The functionality of the cable is dependant on the watertight seal. The sealing compound must be able to adhere to the surface of the cable and the individual wires. Cleaning of the surface before the sealing is done is therefore vital. Some cable manufacturers use fluid lubricants such as silicon oil in their internal processes. These fluids are almost im-

possible to remove from the surface, making a watertight seal almost impossible to create.

10.4 Cable joints

No matter the type of seal, the adhesion between the sealant and the cable is the key to a watertight seal. As stated under 10.3 Drop cables, a clean and oil-free surface on the cable is necessary.

Solvents must never be applied, as it may damage the cable permanently. Only mechanical cleaning may be used, such as drying with a clean cloth, or sandpaper grinding to create a virgin material surface.

Grundfos offers an approved range of cable joints: both resin type and heat shrink joints. When using a non-Grundfos joint, we always recommended to make a 'soft' joint, i.e. when using a resin to make the joint, it must be a soft resin. Polyurethane usually fulfils all requirements for a watertight and flexible joint. In Section 7.6.2 describes the pros and cons for the various types of joints.

10.5 Riser pipes

Grundfos offers the Wellmaster, a flexible riser pipe, as an alternative to standard steel and plastic pipes. This is woven hose has a polyurethane lining, is approved for use in drinking water in several areas, and comes in sizes from 1-8". It is available in lengths up to 200 metres.

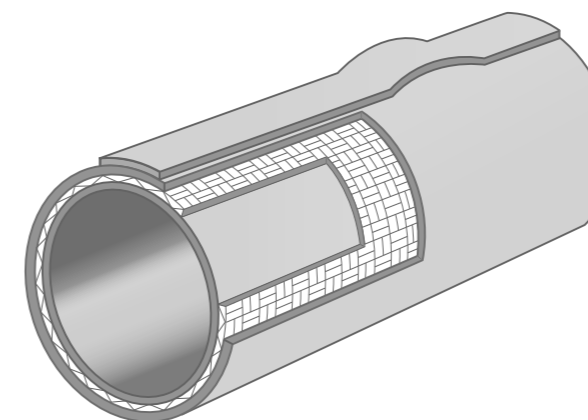

Fig. 69 Cross-section of wellmaster hose
Wellmaster is easy to handle, and does not take up

much space. It swells when pressurised, which minimises the eventual growth of deposits on the inner diameter. A high pumping efficiency is therefore maintained.

Wellmaster is primarily used in combination with aggressive water as an alternative to stainless steel pipes. Some end-users prefer to use Wellmaster in all their installations due to the ease of installation and pulling, and the high quality hose.



For further information about Grundfos, please visit:

www.grundfos.com

Here you can learn much more about the company, our values and find the Grundfos service centre nearest to you. Furthermore you can visit our extensive product selection tool WebCAPS, where you can find exactly the pump you require.

WebCAPS

WebCAPS is Grundfos' online product selection tool that gives you easy access to a wealth of information. Short for Web-based Computer-Aided Product Selection, the WebCAPS interface is easy to use and lets you choose between 24 languages for maximum user-friendliness. It includes a full catalogue of the products available in your country as well as access to literature, CAD drawings – and even service videos.

Sizing function that asks all the relevant questions

The sizing function is a key feature of WebCAPS, designed to help you select the right pump for the job. The programme guides you step by step, asking for all the relevant information. If you are unsure of specific figures or how to calculate them, simply click on the "calculator" icon. WebCAPS will then help you carry out all the calculations necessary to ensure that you get exactly what you need. Every factor will be taken into account, and you won't have to work hard to collect information first.

Replacing a pump? See what we would recommend! The "Replacement" function is a clever little feature for anyone about to replace an existing pump – whether it comes from Grundfos or another supplier. Here, you can search for your existing pump in the drop-down menus, apply various additional criteria if you wish, and click "submit". You then have a complete list of the Grundfos pumps we would recommend as replacements.

CAD drawings

The "CAD Drawings" section is self-explanatory. This is where you go to find CAD drawings of the products you are interested in – just navigate the simple menus to download the information you need to your computer.

11. Additional information

Alphabetic index	chapter	page
Accessories	10	83
Additional information	11	87
Air/gas in water	3.4	20
Applications	3	17
Autotransformer – AT	5.4.3	39
Background	8.5.1	76
Booster modules	3.7	24
Cable joints	10.4	85
Cable selection and sizing	7.5	63
Cable splice/Connection of motor cable and drop cable	7.6.2	65
Cabling guidelines	8.5.3	77
Cathodic protection	10.2.1	83
Communication	8	71
Communications and Networking Technology	8.2	71
Communications Protocol	8.4.2	75
Cooling sleeves	10.1	83
Corrosion protection in seawater	10.2	83
Corrosive water (seawater)	3.5	22
CUE variable speed drive for SP pumps	5.6	43
Current asymmetry	6.6	50
Derating of submersible motor	7.3.6	60
Dewatering	3.2	19
Direct-on-line – DOL	5.4.1	36
Drop cables	10.3	84
Frequency	6.3	48
Frequency converters (variable-speed drive)	5.4.6	40
Freshwater supply	3.1	17
From freshwater sources	2.3.1	14
From the sea and saltwater sources	2.3.2	14
Functional profile	8.4.3	75
Galvanic cathodic protection systems	10.2.2	83
General introduction	8.1	71
Generator operation	7.1.2	67
GENIbus	8.5	76
Grid connection	6.5	49
Groundwater	2.2	9
Groundwater requirement	2.2.3	10
Groundwater wells	2.2.1	9
Grundfos GENIbus products for SP applications	8.6	78
Handling	7.6	65
Horizontal application	3.3	20
Hot water and geothermal water	3.6	23
Impressed current cathodic protection systems	10.2.3	84
Installation & operation	7	53
Introduction	1	7
Mining	3.2.1	19
Motor cables and joints, reference to drop cables	5.2	35
Motor protection devices	5.3	36
Motor types, general description	5.1	33
Motors and controls	5	33

Alphabetic index	chapter	page
Networking basics	8.4	74
Networking topology	8.4.1	74
No. of start/stops	7.9	67
Operation with frequency converter	5.5	42
Overvoltage and undervoltage	6.2.2	47
Power generation	6.1	47
Power supply	6	47
Primary Resistor-type Starter, RR	5.4.4	39
Protection against boiling	7.3.7	61
Pump / motor assembly	7.6.1	65
Pump and motor selection	7.3	56
Pump curves and tolerances	4.4	29
Pump efficiency	7.3.4	57
Pump principle	4.1	27
Pump selection	4.3	28
Pump setting	7.2	56
Pump start up	7.1.0	67
Pumps	4	27
Pumps in parallel operation	7.7	66
Pumps in series operation	7.8	66
Reducing the locked-rotor current	5.4	36
Required raw/well water and water treatment capacity	2.2.4	11
Resources	2.1	9
Riser pipe connections	7.6.3	66
Riser pipe selection	7.4	62
Riser pipes	10.5	85
Riverbank filtration	2.2.2	9
SCADA functions	8.3.2	72
SCADA main parts	8.3.1	72
SCADA systems	8.3	72
Sleeve cooling	7.3.8	61
Soft starter – SS	5.4.5	39
Star-delta – SD	5.4.2	38
Surface water	2.3	14
Technical description	8.5.2	76
The duty point	7.3.1	56
The fieldbus	8.4.4	75
Troubleshooting	9	73
Variable frequency drives	6.4	48
VFD operation	7.1.1	67
Voltage	6.2	47
Voltage unbalance	6.2.1	47
Water supply	2	9
Water temperature	7.3.5	60
Wear parts	4.2	28
Web-hosted SCADA	8.3.3	73
Well diameter	7.3.2	57
Well yield	7.3.3	57
Well yield and operational efficiency	2.2.5	12
Wells and well conditions	7.1	55

BE > THINK > INNOVATE >

Being responsible is our foundation
Thinking ahead makes it possible
Innovation is the essence

GRUNDFOS MANAGEMENT A/S
Poul Due Jensens Vej 7
DK-8850 Bjerringbro
Tel: +45 87 50 14 00
www.grundfos.com

GRUNDFOS 