



Position	Qty.	Description	Single Price
	-1	<p><b>SOLOLIFT2 C-3</b></p>  <p><b>Note! Product picture may differ from actual product</b></p> <p>Product No.: 97775327</p> <p>Sololift2 C-3 is a small, compact automatic lifting station suitable for pumping of greywater (w/o faeces) off places in private dwellings where wastewater cannot be led directly to the sewer by means of a natural downward slope.</p> <p><b>Sololift2 C-3 is typically used for:</b></p> <ul style="list-style-type: none"> <li>• cabinet showers, washbasins, bath tubs, washing machines (max. 90°C) and dishwashers in basements below sewer level or in connection with the renovation or modernisation of existing buildings, where the location may be remote from the main soil pipe so that a natural slope cannot be established.</li> </ul> <p>Sololift2 C-3 is suitable for installation under a washbasin or particularly for confined space conditions in prewall constructions and built-in cabinets. Extremely low switching levels for lowest construction heights, advantageously in case of connection of a shower receptor.</p> <p>The compact lifting station is equipped with</p> <ul style="list-style-type: none"> <li>- Cable with or without plug (see technical data)</li> <li>- Horizontal or vertical fastening possibility of discharge hose connector with several adaptors for pipes with Ø22-40mm</li> <li>- Integrated non return valve</li> <li>- Dry and high performance motor unit incl. thermal protection, level switch and controller</li> <li>- Flexible connectors for inlet (adjustable in height) of pipes Ø36 or 40</li> <li>- Manual anti clogging function and separate drain connection for service</li> <li>- Venting valve with overflow protection</li> <li>- Uplift fixation clips</li> </ul> <p>Design according to EN12050-2 and production inspection by external institute with unique features focused on quick installation, long lasting operation and easy clean service.</p> <p><b>Liquid:</b> Maximum liquid temperature: 75 °C</p> <p><b>Technical:</b> Approvals on nameplate: CE</p> <p><b>Installation:</b> Pump inlet: 32/36/40, 36/40/50</p>	On request

Position	Qty.	Description	Single Price
		Pump outlet: 22/25/28/32/36/40 Number of leads: 3X0,75MM2  <b>Electrical data:</b> Power input - P1: 0.64 kW Mains frequency: 50 Hz Rated voltage: 1 x 220-240 V Rated current: 3.1 A Cos phi - power factor: 0,9 Rated speed: 2800 rpm Enclosure class (IEC 34-5): 24 Insulation class (IEC 85): F Length of cable: 1.2 m Cable type: H05VV-F Type of cable plug: TYPE I Others: Net weight: 6.53 kg Gross weight: 8.1 kg	



**97775327 SOLOLIFT2 C-3 50 Hz**

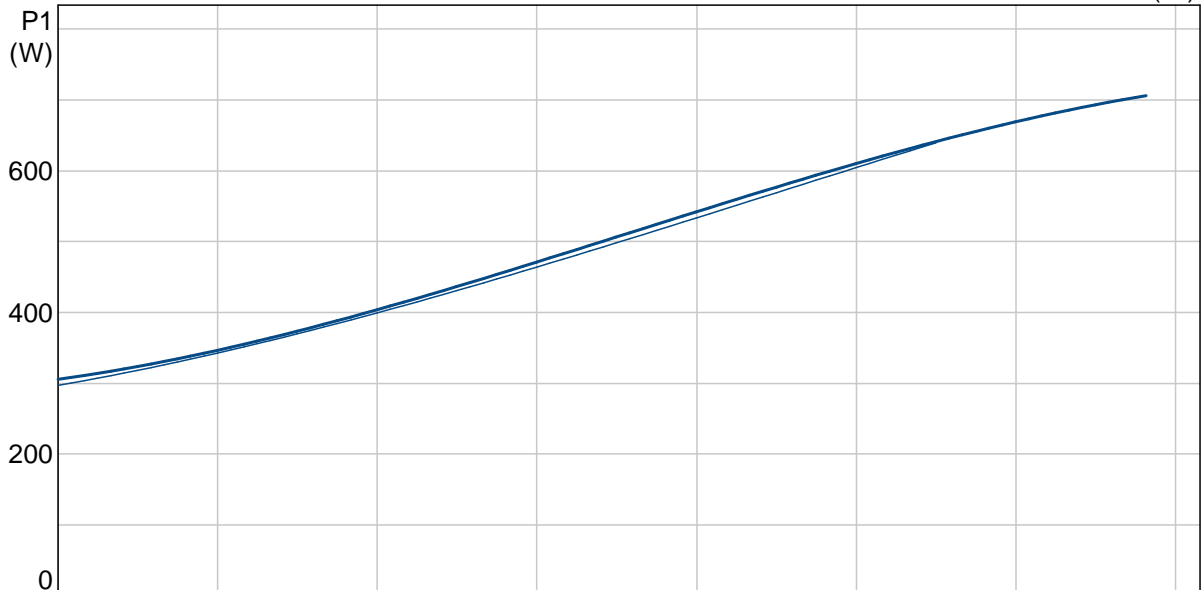
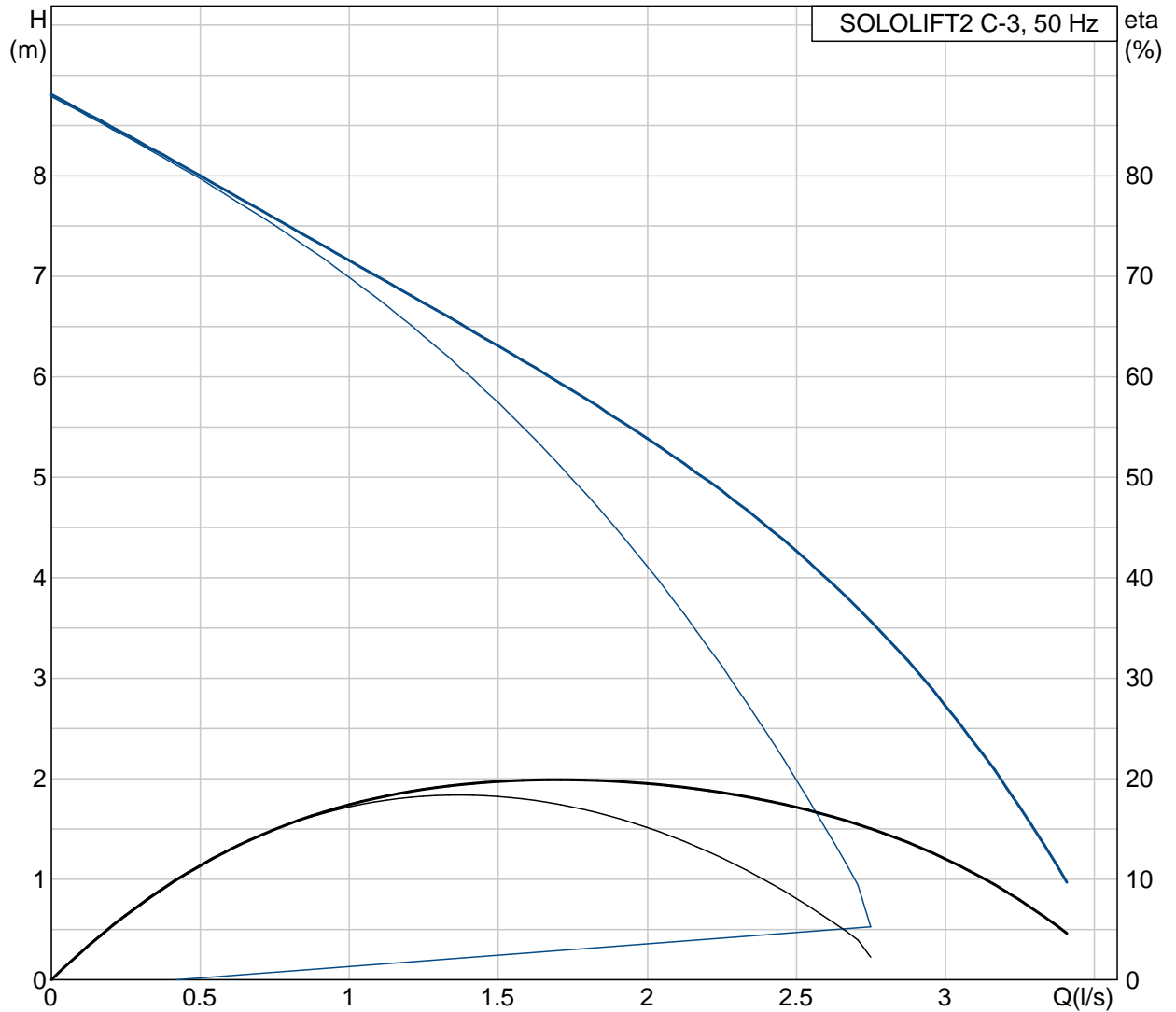

Description	Value
Product name:	SOLOLIFT2 C-3
Product No:	97775327
EAN number:	5710624187364
<b>Technical:</b>	
Head max:	8.5 m
Approvals on nameplate:	CE
<b>Installation:</b>	
Pump inlet:	32/36/40, 36/40/50
Pump outlet:	22/25/28/32/36/40
Number of leads:	3X0,75MM2
<b>Liquid:</b>	
Maximum liquid temperature:	75 °C
<b>Electrical data:</b>	
Power input - P1:	0.64 kW
Mains frequency:	50 Hz
Rated voltage:	1 x 220-240 V
Rated current:	3.1 A
Cos phi - power factor	0,9
Rated speed:	2800 rpm
Enclosure class (IEC 34-5):	24
Insulation class (IEC 85):	F
Thermal protec:	THERMIK S06-140-05
Length of cable:	1.2 m
Cable type:	H05VV-F
Type of cable plug:	TYPE I
<b>Others:</b>	
Net weight:	6.53 kg
Gross weight:	8.1 kg
Product range:	Australia

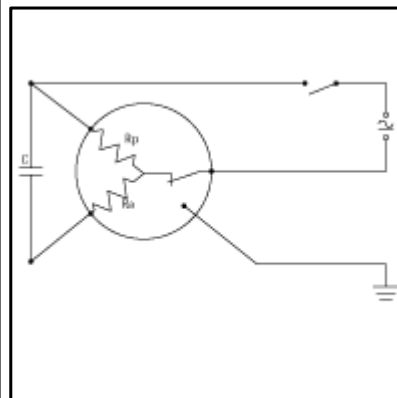
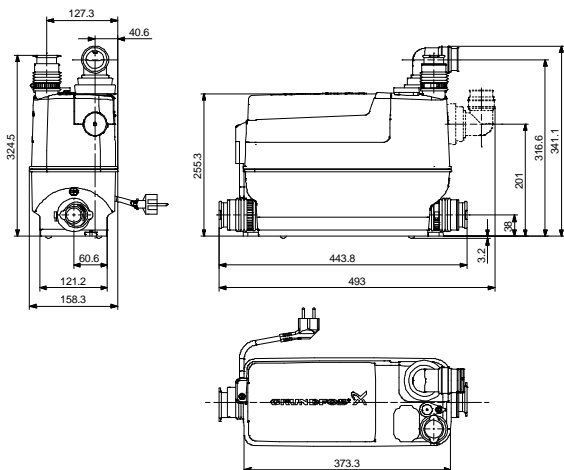
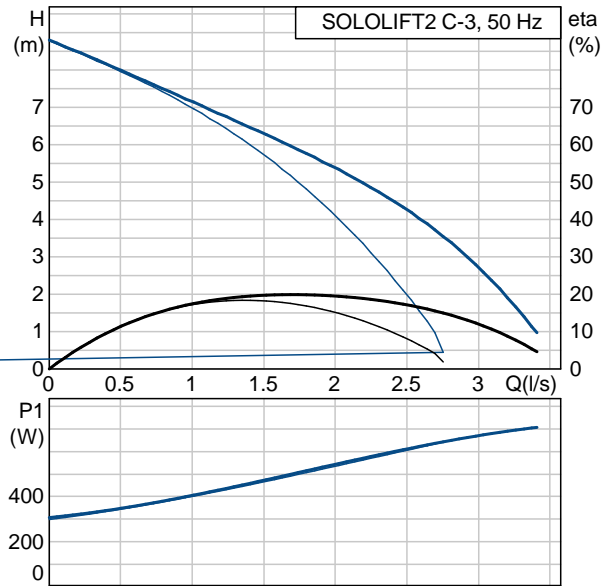



**97775327 SOLOLIFT2 C-3 50 Hz**

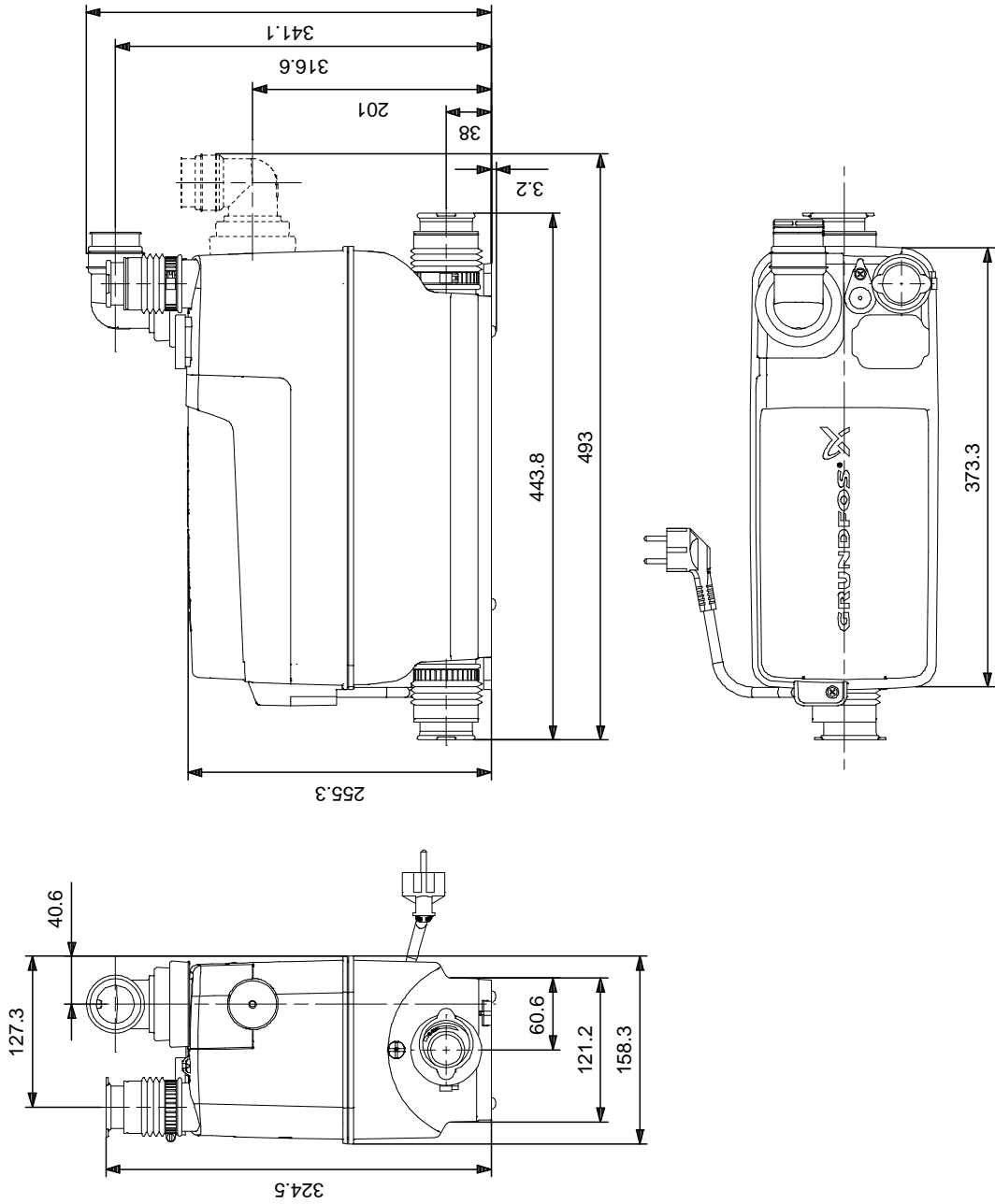

Note! All units are in [mm] unless others are stated.  
 Disclaimer: This simplified dimensional drawing does not show all details.

**97775327 SOLOLIFT2 C-3 50 Hz**

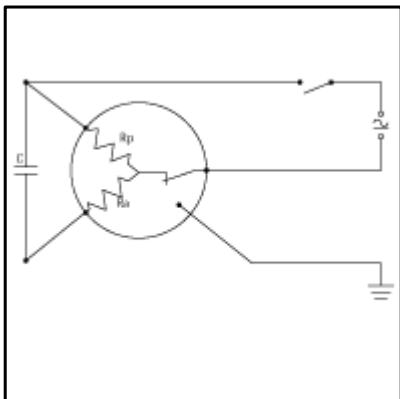

Note! All units are in [mm] unless others are stated.